

LED LIGHTING

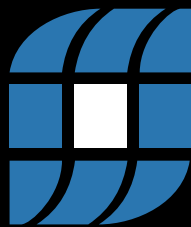

**PIDLED
LIGHTING**

SINCE 2008

2022

VOL. 02

PRODUCT CATALOGUE



LEADERS IN THE LED LIGHTING INDUSTRY

For every individual in search of lighting, we have a product. Whether you're meeting a budget or conforming to highly specific applications, you can trust that we have a suitable luminaire. PioLED lighting is specifically designed to suit conditions found in the South African market, providing brighter solutions for a power-efficient tomorrow. Our aim is to become the most trusted LED lighting supplier in South Africa, through outstanding service and impeccable quality.

Since PioLED's inception in 2008, we have strived to remain ahead of the curve when it comes to LED trends, constantly evolving and advancing to maintain our reputation as Pioneers in the South African LED industry.

Our head office is located in South Africa's largest port of Durban, and makes reliable and efficient deliveries to respective businesses across the country. We pride ourselves on making these deliveries in excellent time – typically within one to two working days. Our friendly staff in Durban, Johannesburg, Cape Town and the Eastern Cape are there to assist you in any way possible, should you require further technical information.



**DELIVERY
AVAILABLE**



**HIGH
QUALITY**



**BUDGET
FRIENDLY**



**FAST
SERVICE**



**WHATSAPP
UPDATES**



**TECHNICAL
SUPPORT**

CONTENTS



7 Heavy Duty
Corn Lamp



8 Heavy Duty E40
Highbay Lamp



9 A60 9.5W LED
Lamp



10 A55 6W Filament
LED Lamp



12 G95 LED Filament
Clear Lamp



13 Pear LED Filament
Clear Lamp



14 4W LED Filament
Candle



16 QuRi Smart
Lighting

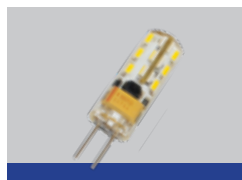

18 G4 12V Capsule
Lamp



19 G9 220V Lamp



20 4.5W LED GU10



21 5.5W LED GU10



22 4W LED GU10



23 6W Combat LED
GU10



24 6W LED
Professional
GU10



25 9W LED GU10



26 Flare 6W
Rechargeable
GU10



28 Punch High Power Downlighters



30 GU10 Holder and Aluminium Fixtures



32 Thor Coastal Floodlights



36 Modular LED Floodlights



38 Combat LED Floodlights



42 IP65 Combat LED Sensor Floodlights



44 Patrol Day & Night Sensor Floodlights



46 Nano Floodlights



48 Nano EVO Floodlights



50 Nano/Nano EVO Sensor Floodlights



52 Back-lit LED Panels



54 Luna 3 CCT Round Ceiling Lights



56 LED Recessed Round Ceiling Lights



58 Iris LED 2 in 1 Round Ceiling Lights



61 Helios UFO Highbay



62 Samurai Dimmable Highbay



64 160W Heavy Duty UFO Highbay



66 Kratos Linear Highbay

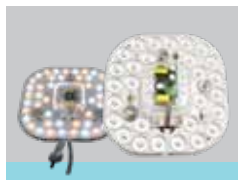

68 Retrofit Modules



70 IP65 Super Slim Linear Lights



72 IP33 Project Linear Lights

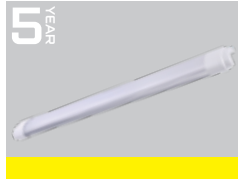

74 IP65 Premium LED Linear Lights

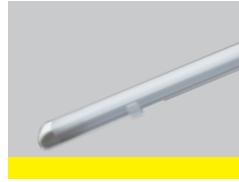

75 Nano Linear Lights

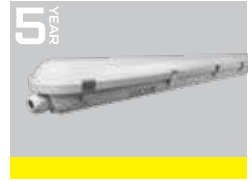

76 LYNX Tri-Proof Linear



77 Zen Tri-Proof Fixture



78 T8 LED Combat Tubes



80 T8 LED Premium Tubes



82 T5 Combat LED Tubes



84 Bazuka 35W Track Spot Light 3 Wire/Surface



85 Bazuka accessories



86 Snypa LED Spot Fixtures



88 Sylo Surface Mount Wall Light Fixtures



89 Pandora LED Wall Light



90 12V/24V IP20/IP67 Strip Lights



94 24V COB Dotless Strip



95 230V COB Dotless Strip

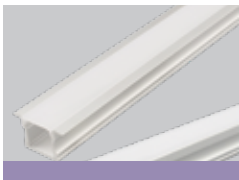

96 LED Profiles



98 LED 230V Rope Lights



101 LED Drivers



102 PiOLED Floodlight Coverage



HEAVY DUTY CORN LAMP



Certificates: CE, RoHS, TM21

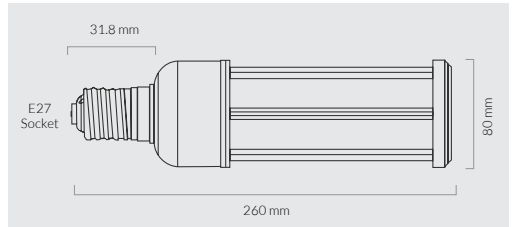

FEATURES

- Industrial Grade, 54W, **E27 Retrofit LED lamp** with a built in 3kV Surge Protection.
- **360° Wide Beam angle** ensuring maximum uniformity whilst reducing hot spots.
- **Flicker free** LED driver, ideal for warehouse/factory installations as it will not interfere with cameras.
- **L80B10 @ 50 000hrs** rated lifespan allowing for minimal lumen decay through the products life.
- **5 Year Warranty** E27 lamp with **Pure Aluminium housing** delivering 7 800lm @ 140lm/W.
- **Industrial Spec 5700K** colour temperature with a CRI >80, ensuring crisp and even lighting whilst enhancing visibility.
- Wide input voltage of **100-277V** creating a robust LED lamp.

CODE	DESCRIPTION	LUMEN OUTPUT	CRI	BEAM	INPUT VOLTAGE	HOUSING	OPERATING TEMP	LED CHIPS
B033	Heavy Duty Corn Bulb IP44 E27 54W 5700K	7 800	>80	360	100V-277V	PC & Pure Alu	-20-40°C	2835 Jucan
B033A	E27 to E40 Adaptor							

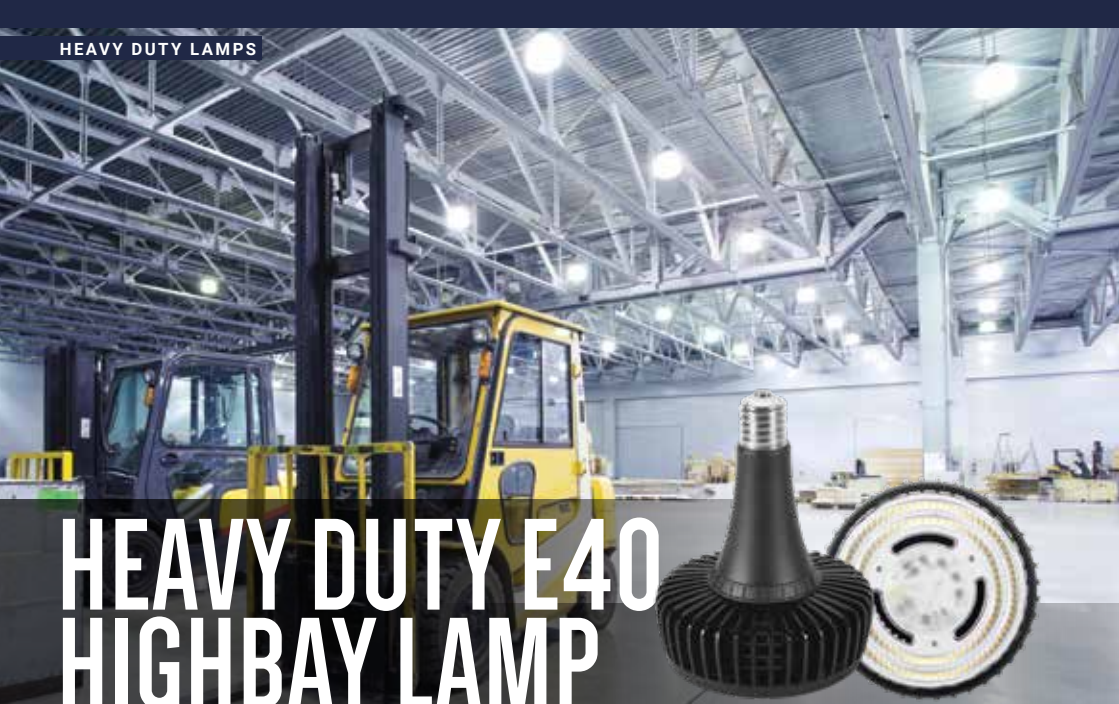

120 LUMEN PER WATT
IP 50
2 SURGE PROTECTION (KV)
2 YEAR WARRANTY
100W
6000K (CW)

170 LUMEN PER WATT
IP 50
3 SURGE PROTECTION (KV)
3 YEAR WARRANTY
150W
6000K (CW)

Certificates: CE, EMC, IEC60598

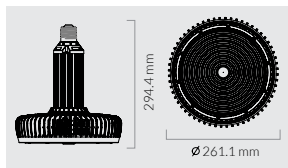
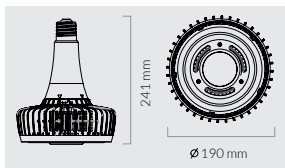

FEATURES

- Powerful, compact LED lamp designed as a **direct replacement to 250W/400W HID lamps**.
- **Pure Aluminium Heat Fins** providing as heatsink effectively dissipating heat increasing the LED lifespan.
- Unique Design allowing for **quick and easy retrofits**. Ballast is required to be bypassed as this lamp requires a straight 220V connection.
- Highly efficient LED lamp producing an effective **lumen output > 120 lm/W for 100W and 170 lm/W for 150W**.
- Built in **2kV (100W) & 3kV (150W) Surge protection** creating a robust lamp for demanding environments.
- Ideal for use in **commercial / industrial** applications.

CODE	DESCRIPTION	LUMEN OUTPUT	CRI	BEAM	INPUT VOLTAGE	HOUSING	OPERATING TEMP	LED CHIPS
HB008	100W Heavy Duty IP50 E40 Highbay Lamp 6000K	12 000	>83	90D	180V-300V	Pure Alu heat fins	-20~40°C	2835 Epistar
HB011	150W Heavy Duty IP50 E40 Highbay Lamp 6000K	25 500						

A60 9.5W LED LAMP

BASES

ES (E27)

BC (B22)

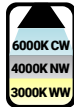
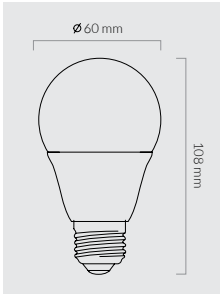

Certificates: CE, EMC



FEATURES

- Heat conductive polycarbonate housing with internal aluminium providing as a **durable heat sink** increasing the lifespan of the LEDs.
- **Frosted Style** LED lamp reducing the amount of glare whilst still providing excellent light output
- 2835 SMD LED Chips allowing for a uniform light output with a **210° beam angle**.
- Maintenance free, environmentally friendly alternative to incandescent lamps which contain no mercury, lead or other harmful substances.
- High **CRI >80** LED Lamp allowing for true colour rendering.
- Wide input voltage range from **170V-265V** with a built in 0.5kV surge protection.
- The ideal domestic lamp when making the LED conversion.

CODE	DESCRIPTION	LUMEN OUTPUT	CRI	BEAM	INPUT VOLTAGE	HOUSING	OPERATING TEMP	LED CHIPS
B016	A60 9.5W LED Lamp 6000K ES	720	>83	210°	170V- 265V	PC & Internal Alu	-10~40°C	2835 Sanan
B017	A60 9.5W LED Lamp 3000K ES							
B018	A60 9.5W LED Lamp 4000K ES							
B019	A60 9.5W LED Lamp 6000K BC							
B020	A60 9.5W LED Lamp 3000K BC							

A55 6W FILAMENT LED LAMP

A55 Filament 6W Lamp
available in **clear** or **frosted**

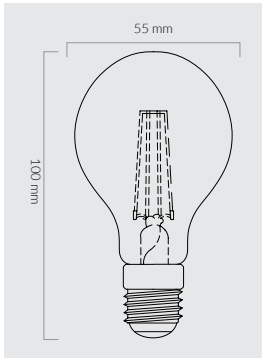

Certificates: CE, EMC, RoHS, ISO9001

FEATURES

- **Glass housing** providing excellent thermal management allowing for an increased lifespan of the lamp.
- **Filament style LED Chips** providing a full 360° beam angle providing an even, uniform light distribution without any dark spots.
- Available in both dimmable and non-dimmable variations.
- Available in either **clear** or **frosted** variations, the latter helping in the reduction of UGR.
- High performance LED Lamp giving you a bright, yet **comfortable ambience**.
- The filament style lamp has the ability to create a **soft, cosy atmosphere** whilst still providing ample illumination.
- The direct replacement to incandescent lamps with an effective lumen output of up to **115lm/W**.
- Durable LED Lamp with a built in 1kV surge protector.
- Instant 100% light output with no warm-up time.



CODE	DESCRIPTION	LUMEN OUTPUT	CRI	BEAM	INPUT VOLTAGE	HOUSING	OPERATING TEMP	LED CHIPS
B021	A55 6W LED Filament Clear Lamp 6000K ES	700	>83	360°	220V- 240V	Clear	-20~40°C	Filament
B021F	A55 6W LED Filament Frosted Lamp 6000K ES					Frosted		
B022	A55 6W LED Filament Clear Lamp 3000K ES					Clear		
B022F	A55 6W LED Filament Frosted Lamp 3000K ES					Frosted		
B023	A55 6W LED Filament Clear Lamp 6000K BC					Clear		
B024	A55 6W LED Filament Clear Lamp 3000K BC					Clear		
BD021F	A55 6W LED Filament Frosted Lamp 6000K ES Dim					Frosted		
BD022F	A55 6W LED Filament Frosted Lamp 3000K ES Dim					Frosted		
BD022	A55 6W LED Filament Clear Lamp 3000K ES Dim					Clear		

G95 LED FILAMENT CLEAR LAMP

BASES

ES (E27)



Certificates: CE, EMC

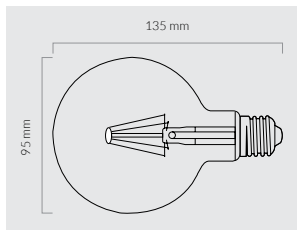

FEATURES

- **Full Glass housing**, designed to quickly dissipate heat increasing the lifespan of the LED Lamp.
- **Vintage Styled LED Filament** lamp with a **360° beam angle**, giving off maximum coverage and uniformity.
- Highly efficient filament LED Chips delivering an **effective 100lm/W** maximizing energy efficiency.
- Available in 3000K or 4000K and in **dimable** allowing you to set the perfect atmosphere at any given time.
- The direct replacement to incandescent lamps whilst providing an environmentally friendly alternative containing no mercury, lead or other harmful substances.

CODE	DESCRIPTION	LUMEN OUTPUT	CRI	BEAM	INPUT VOLTAGE	HOUSING	OPERATING TEMP	LED CHIPS
BD001	G95 6W LED Filament Clear Lamp 3000K Dim	600	>80	360°	220V- 240V	Glass	-20~40°C	Filament 38
BD002	G95 6W LED Filament Clear Lamp 4000K Dim							



PEAR LED FILAMENT CLEAR LAMP

BASES

ES (E27)

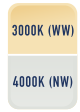

Certificates: CE, EMC

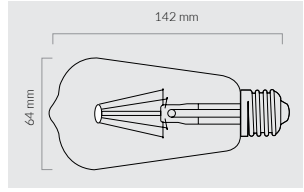

FEATURES

- **Full Glass housing**, designed to quickly dissipate heat increasing the lifespan of the LED Lamp.
- **Vintage Styled LED Filament** lamp with a **360° beam angle**, giving off maximum coverage and uniformity.
- Highly efficient filament LED Chips delivering an **effective 100lm/W** maximizing energy efficiency.
- Available in 3000K or 4000K and in **dimable** allowing you to set the perfect atmosphere at any given time.
- The direct replacement to incandescent lamps whilst providing an environmentally friendly alternative containing no mercury, lead or other harmful substances.

CODE	DESCRIPTION	LUMEN OUTPUT	CRI	BEAM	INPUT VOLTAGE	HOUSING	OPERATING TEMP	LED CHIPS
BD005	Pear 6W LED Filament Clear Lamp 3000K Dim	600	>80	360°	220V- 240V	Glass	-20~40°C	Filament 52
BD006	Pear 6W LED Filament Clear Lamp 4000K Dim							

4W LED FILAMENT CANDLE

BASES

SES (E14)

ES (E27)

BC (B22)

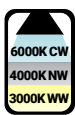
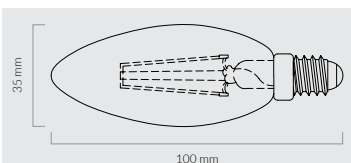

Certificates: CE, EMC, RoHS, ISO9001

4W LED filament candle available in clear or frosted

FEATURES

- Full Glass body thermally tested to ensure adequate **heat dissipation** from the lamp extending the overall lifespan of the LEDs.
- **Filament style LED array**, providing for a more traditional ambience – ideal for adding character to a room.
- **Available in a frosted** variant reducing the amount of glare whilst still providing excellent light output.
- Available in all common bases, namely E27, E14 and BC allowing for a quick and easy installation/retrofit.
- **360° beam angle** providing a **uniform**, even light distribution.
- Available in a **dimnable option** allowing you to create the perfect atmosphere at any time.
- Highly efficient LED filament with up to **440 effective lumens**.
- Serves as a direct **replacement to halogen/incandescent** lamps containing no mercury, lead or other harmful substances.
- Built in **1kV surge protection** with a wide voltage range of **220-240V** increasing the durability of the lamp.

CODE	DESCRIPTION	LUMEN OUTPUT	CRI	BEAM	INPUT VOLTAGE	HOUSING	OPERATING TEMP
CF001	Filament 4W LED Clear Candle SES-6000K	440lm	> 80	360°	220-240V	Clear Glass	-20~40°C
CF002	Filament 4W LED Clear Candle SES-3000K					Clear Glass	
CF003	Filament 4W LED Clear Candle ES-6000K					Clear Glass	
CF004	Filament 4W LED Clear Candle ES-3000K					Clear Glass	
CF005	Filament 4W LED Clear Candle BC-6000K					Clear Glass	
CF006	Filament 4W LED Clear Candle BC-3000K					Clear Glass	
CFD01	Filament 4W LED Clear Candle SES-6000K Dim					Clear Glass	
CFD02	Filament 4W LED Clear Candle SES-3000K Dim					Clear Glass	
CFF001	Filament 4W LED Frost Candle SES-6000K					Frost Glass	
CFF002	Filament 4W LED Frost Candle SES-3000K					Frost Glass	
CFF007	Filament 4W LED Frost Candle SES-4000K					Frost Glass	
CFF003	Filament 4W LED Frost Candle ES-6000K					Frost Glass	
CFF004	Filament 4W LED Frost Candle ES-3000K					Frost Glass	
CFF005	Filament 4W LED Frost Candle BC-6000K					Frost Glass	
CFF006	Filament 4W LED Frost Candle BC-3000K					Frost Glass	
CFF009	Filament 4W LED Frost Candle BC-4000K					Frost Glass	
CFDF01	Filament 4W LED Frost Candle SES-6000K Dim					Frost Glass	
CFDF02	Filament 4W LED Frost Candle SES-3000K Dim					Frost Glass	
CFDF07	Filament 4W LED Frost Candle SES-4000K Dim					Frost Glass	
CFDF03	Filament 4W LED Frost Candle ES-6000K Dim					Frost Glass	
CFDF04	Filament 4W LED Frost Candle ES-3000K Dim					Frost Glass	
CFDF05	Filament 4W LED Frost Candle BC-6000K Dim					Frost Glass	
CFDF06	Filament 4W LED Frost Candle BC-3000K Dim					Frost Glass	
CFDF09	Filament 4W LED Frost Candle BC-4000K Dim					Frost Glass	
CFDF08	Filament 4W LED Frost Candle ES-4000K Dim					Frost Glass	





SMART LIGHTING

compatible with
Alexa

compatible with
Google Assistant

GET IT ON
Google Play

Download on the
App Store

tuya

Smart Life

Remote control

RGB+3CCT

FEATURES

- Smart LED Range, controllable either via remote, **Google Home**, **Alexa**, **Tuya** or through the **Smart Life App**.
- Controllable **individually** or can be **grouped** together to allow for quick and efficient syncing.
- Dimmable product with over **16 Million colours** to choose from.
- In App, selectable **lighting scenes**, **music mode** or **preselected timing function**.
- Connects via **WiFi** to allow lamps to be controlled, as long as an internet connection is provided.

ENJOY A WORLD FULL OF COLOUR WITH OUR QURI DEMONSTRATION VIDEOS.

- ✓ Dimmable (0-100%)
- ✓ RGB and CCTs (16 million colour options)
- ✓ Controllable via Remote
- ✓ Controllable via the Smart Life/Tuya App
- ✓ Hands-free control with Alexa and Google Home
- ✓ Customisable Scenes
- ✓ Set a Timer or Schedule via the App
- ✓ Music mode
- ✓ Group to Control QuRi range
- ✓ Supports 2.4GHz Wi-Fi Networks
- ✓ Live in colour!

PART 1



PART 2



QURI G95 11W LED SMART WIFI E27 LAMP + REMOTE



Certificates: CE, EMC, RoHS, ISO9001

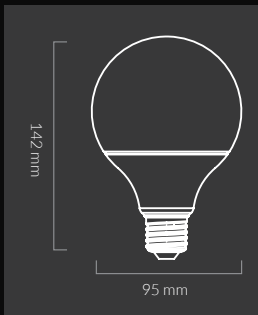

QURI A60 10W LED SMART WIFI E27 LAMP + REMOTE



Certificates: CE, EMC, RoHS, ISO9001

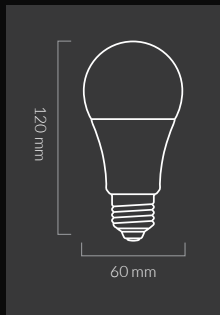

QURI 24W SMART ROUND WIFI CEILING LIGHT + REMOTE



Certificates: CE, EMC, RoHS, ISO9001

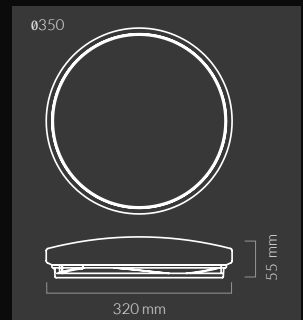

CODE	DESCRIPTION	LUMEN OUTPUT	CRI	BEAM	INPUT VOLTAGE	HOUSING	OPERATING TEMP	LED CHIPS
B025	A60 E27 10W QuRi LED Smart WiFi Lamp + Remote	850	>80	210°	220V- 240V	PC & Alu		
IC006	24W QuRi LED Smart Round WiFi Ceiling Light + Remote	1 680	>80	120°	180V- 265V	Alu PCB + Metal & PC	-20~40°C	2835 Sanan
B026	G95 E27 11W QuRi LED Smart WiFi Lamp + Remote	1 100	>80	210°	220V- 240V	PC & Alu		



G4 12V CAPSULE LAMP

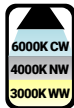

Certificates: CE, EMC

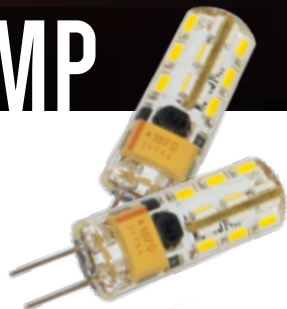
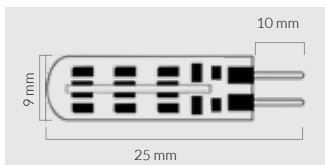

FEATURES

- 3014 SMD LED Chips delivering an effective **100 lumens**.
- **DC12V LED** Lamp designed for MR16 lampholders.
- Best performance when coupled with our 12V DC CV LED Drivers.
- Resin based housing with a 320° wide beam distribution.
- Instant on LED lamp with no warm up time.
- Reduce your electrical consumption by up to 90% in comparison to Halogen alternatives.
- No Mercury, Lead or other harmful substances.

CODE	DESCRIPTION	LUMEN OUTPUT	CRI	BEAM	INPUT VOLTAGE	HOUSING	OPERATING TEMP	LED CHIPS
G001	G4 1.5W LED Bi-Pin Lamp 12V 6000K	100	>83	320°	12V	Resin	-10~40°C	3014 SMD
G002	G4 1.5W LED Bi-Pin Lamp 12V 3000K							
G003	G4 1.5W LED Bi-Pin Lamp 12V 4000K							
G008	G4 1.5W LED Bi-Pin Lamp 12V Blue							



G9 220V LAMP



1
YEAR
WARRANTY

3W

6000K CW
4000K NW
3000K WW

Certificates: RoHS, ISO9001

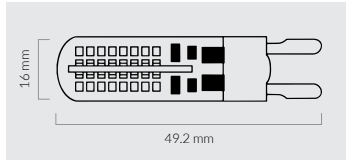

FEATURES

- Resin based housing designed to fit into fixtures that carry a G9 lampholder base.
- **Direct 220V** requiring no need for an LED driver.
- Powerful 3014 SMD LED Chips providing an effective 200 lumens.
- Available in Warm White, Neutral White and Cool White helping to create the perfect atmosphere.
- Wide **320° beam angle** preventing dark spots whilst allowing for maximum coverage.
- **Instant on LED** with no warm up time.

CODE	DESCRIPTION	LUMEN OUTPUT	CRI	BEAM	INPUT VOLTAGE	HOUSING	OPERATING TEMP	LED CHIPS
G005	G9 3W LED Lamp 6000K	200						
G006	G9 3W LED Lamp 3000K	200	>83	320°	200-240V	Resin	-10~40°C	3014 SMD
G007	G9 3W LED Lamp 4000K	200						

4.5W LED GU10/MR16 DOWNLIGHTER

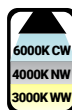
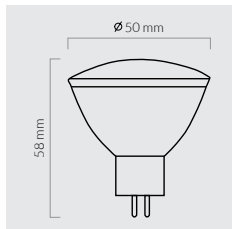
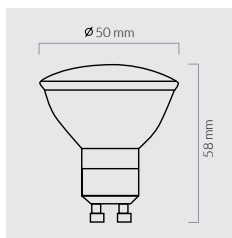

Certificates: CE, EMC, RoHS, ISO90001

FEATURES

- Thermally tested pure aluminium housing designed to **dissipate heat** away from the LEDs a lot quicker than PC housing
- Available in a dimmable option helping to create the **perfect atmosphere** for your setting.
- **Premium LED lamp** with a rated life of up to 30 000hrs.
- Frosted styled diffuser with a **wide 120° beam angle** allowing for maximum coverage.
- **High CRI>80** rendering true colours – Extremely good for Kitchens.
- The ideal lamp for **demanding applications** and for those who want hassle free illumination.

CODE	DESCRIPTION	LUMEN OUTPUT	CRI	BEAM	INPUT VOLTAGE	HOUSING	OPERATING TEMP	LED CHIPS
D020	4.5W LED Durable GU10 6000K	400	>83	120°	85V-265V	Pure Alu	-10~40°C	2835 Sanan
D021	4.5W LED Durable GU10 3000K				85V-265V			
D022	4.5W LED Durable GU10 4000K				85V-265V			
D023	4.5W LED Durable GU10 6000K 12V				12V			
D024	4.5W LED Durable GU10 3000K 12V				12V			
D025	4.5W LED Durable GU10 4000K 12V				12V			
DD012	4.5W LED Durable GU10 6000K Dim				85V-265V			
DD013	4.5W LED Durable GU10 3000K Dim				85V-265V			
DD014	4.5W LED Durable GU10 4000K Dim				85V-265V			



5.5W LED GU10 DOWNLIGHTER

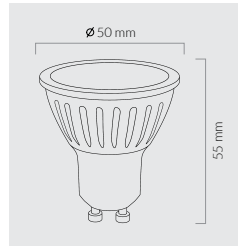
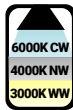

Certificates: CE,EMC,RoHS,ISO9001

FEATURES

- Heat Conductive polycarbonate housing coupled with **internal aluminium** to produce a robust lamp.
- Frosted glazed diffuser **reducing the glare** and visibility of the 2835 SMD LED chips.
- **120° wide beam angle**, covering large surface areas ensuring maximum uniformity.
- Highly efficient LED Lamp with an effective lumen output of up to **550lm**.
- High performance LED Lamp giving you a bright, yet comfortable ambience.
- **Instant on LED** with no warm up time.
- Environmentally friendly choice serving as a direct replacement to **50W** Halogen lamps.
- The ideal lamp for day to day residential usage with built in **1kv surge protection**.

CODE	DESCRIPTION	LUMEN OUTPUT	CRI	BEAM	INPUT VOLTAGE	HOUSING	OPERATING TEMP	LED CHIPS
D004	5.5W LED Econo GU10 4000K	550	>83	120°	220V- 240V	Plastic + internal Alu	-10~40°C	2835 SMD
D005	5.5W LED Econo GU10 6000K							
D006	5.5W LED Econo GU10 3000K							
DD004	5.5W LED Econo GU10 4000K Dim							
DD005	5.5W LED Econo GU10 6000K Dim							
DD006	5.5W LED Econo GU10 3000K Dim							

4W LED GU10 DOWNLIGHTER

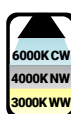

Certificates: CE, EMC, RoHS, ISO9001

FEATURES

- Perfectly suitable for **enclosed/up-down light** fittings.
- **Honeycomb inspired lens** containing 3pcs high lumen SMD LED Chips with built in 1kV surge protection.
- Available in 3000K, 4000K, 6000K, **Red, Blue, Green** and **Magenta** coupled with a **45° narrow beam** designed to enhance architectural features.
- Contains no mercury, lead or harmful substances.
- Pure aluminium thermal management system **designed for a 7W LED** making it suitable for up-down light fitting.
- Robust LED Lamp featuring the **Japanese Rubycon capacitor**.
- **High CRI >80** (3000K/4000K/6000K) allowing for crisp true colour rendering.
- **Philips 3030** High Lumen LED Chips.
- Instant on LED with no warm up time.
- Environmentally friendly alternative containing no mercury, lead or any other harmful substances.

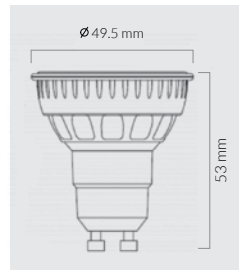
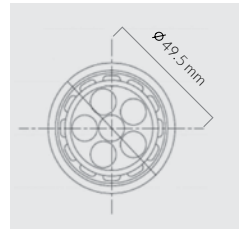

CODE	DESCRIPTION	LUMEN OUTPUT	CRI	BEAM	INPUT VOLTAGE	HOUSING	OPERATING TEMP	LED CHIPS
D016	4W LED Colour GU10 Green	280	>83	45°	100V-277V	Pure Alu	-10~40°C	Philips 3030
D017	4W LED Colour GU10 Blue							
D018	4W LED Colour GU10 Magenta							
D019	4W LED Colour GU10 Red							
D010	4W LED GU10 4000K	280	>83	60°	100V-277V	Pure Alu	-10~40°C	Philips 3030
D011	4W LED GU10 6000K							
D012	4W LED GU10 3000K							

6W COMBAT LED GU10 DOWNLIGHTER



Certificates: CE, RoHS, EMC, ErP

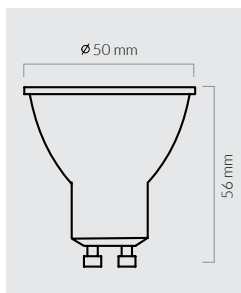

FEATURES

- Thermoplastic housing coupled with **internal aluminium** and Silicone for a cost effective durable GU10 solution.
- Available in a Dimmable option, with a smooth **0-100% dimming range**.
- 60° beam angle GU10 with our Low Glare, **Comfort Lens**.
- Highly Efficient 2835 SMD LED Chips delivering up to **110lm/W**.
- Available in Colour temperatures of 3000K/4000K/6000K.
- Wide Voltage Range **170V-277V** designed specifically for the South African Market.
- Environmentally friendly choice serving as a direct replacement to 50W Halogen lamps.
- Suitable for **Sylo** PC housing UP & DOWN IP65 fixture (Pg 88).

CODE	DESCRIPTION	LUMEN OUTPUT	CRI	BEAM	INPUT VOLTAGE	HOUSING	OPERATING TEMP	LED CHIPS
D026	6W LED Combat GU10 6000K	650	>83	60°	170V-277V	PC + Alu	-20~40°C	2835 Epistar
D027	6W LED Combat GU10 3000K							
D028	6W LED Combat GU10 4000K							
DD026	6W LED Combat GU10 6000K Dim							
DD027	6W LED Combat GU10 3000K Dim							
DD028	6W LED Combat GU10 4000K Dim							

6W LED PROFESSIONAL GU10 DOWNLIGHTER

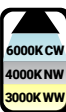
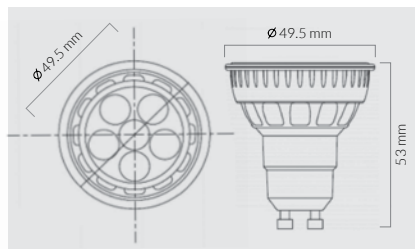

Certificates: CE, EMC, RoHS, ISO9001

*5 Year Warranty is effective from Batch 2203 onwards

PHILIPS *Rubycon*

FEATURES

- Thermally tested and precisely positioned **pure aluminium** heat fins providing as its thermal management system, increasing the lifespan of the LEDs.
- 6pcs **Philips 3030** high lumen LED Chips delivering an effective **100lm/W**.
- Designed to withstand the most challenging/harsh environments with its built in **Japanese Rubycon Capacitor**.
- **Honeycomb lens** offering the highest levels of clarity and comfort.
- Dimmable variant optional with market leading, **true 10-100% dimming**.
- Featuring the latest electronic components producing a **PF>0.9**.
- **High CRI>80** with a **60° beam** angle, reducing light spillage.
- Current waveform is almost 100% sine wave producing **little to no harmonics**.
- Maintenance free, environmentally friendly alternative to halogen lamps which contains no mercury, lead or other harmful substances.

CODE	DESCRIPTION	LUMEN OUTPUT	CRI	BEAM	INPUT VOLTAGE	HOUSING	OPERATING TEMP	LED CHIPS
D013	6W LED Professional GU10 6000K	600	>83	60°	100V-277V	Pure Alu	-10~40°C	Philips 3030
D014	6W LED Professional GU10 3000K							
D015	6W LED Professional GU10 4000K							
DD009	6W LED Professional GU10 6000K Dim							
DD010	6W LED Professional GU10 3000K Dim							
DD011	6W LED Professional GU10 4000K Dim							

9W LED GU10 DOWNLIGHTER



For Double-volume ceilings



Certificates: CE, EMC, RoHS, ISO90001

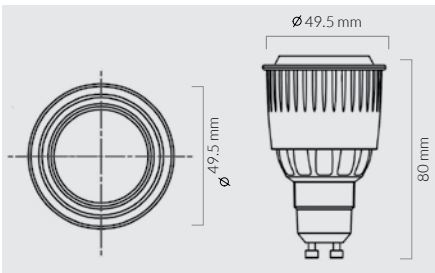

FEATURES

- **Pure aluminium housing** allowing for maximum heat dissipation.
- **High Lumen COB LED** Chip delivering an effective 900lm.
- Robust LED lamp built with a **Japanese Rubycon capacitor**.
- **Dimmable variant** allowing you to set your atmospheric mood.
- **45° narrow beam angle** – ideal for double volume ceilings or demanding applications.
- **High CRI>80** with a deep reflector helping reduce glare.
- Contains no mercury, lead or harmful substances.

CODE	DESCRIPTION	LUMEN OUTPUT	CRI	BEAM	INPUT VOLTAGE	HOUSING	OPERATING TEMP	LED CHIPS
D007	9W LED High Power GU10 5000K	900	>83	45°	100V-277V	Pure Alu	-10~40°C	COB
D008	9W LED High Power GU10 3000K							
DD007	9W LED High Power GU10 5000K Dim							
DD008	9W LED High Power GU10 3000K Dim							



6W RECHARGEABLE LED GU10



Certificates: MSNS, UN38.3, CE-LVD, CB & RoHS

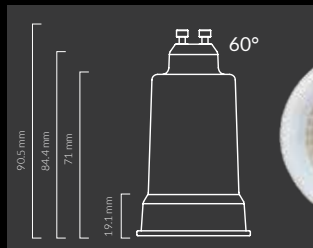
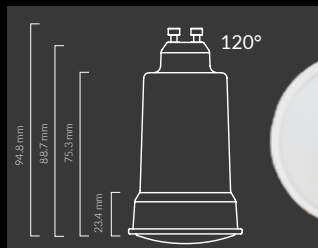

FEATURES

- **Ultra Convenient 3CCT LED GU10 lamp** with colour temperatures of 3000K/4000K or 6000K adjustable via our built in Dipswitch.
- 3.7V 1400mah **Lithium Ion battery** allowing for 3 hours running time whilst lamp is operational on Battery Mode.
- **5-6 working hours is required for the lamp to reach a full charge once the battery is fully depleted.**
- Battery mode is instantly activated when **Load Shedding or a power failure occurs**, with the lamps operation being controlled via your light switch. The lamp will instantly drop to a 4W with a 4000K colour temperature.
- **Wide input voltage range 180V-277V** designed specifically for use in the South African Market. This lamp is further protected with a built in 1kV surge protection.
- **High CRI>80 Epistar LED Chips** delivering an impressive 90lm/w in **beam angles of either 120D or 60D.**
- Rechargeable Flare GU10 to only be installed in **non dimmable LED Lighting circuits** and circuits where sensors aren't used.

CODE	DESCRIPTION	LUMEN OUTPUT	CRI	BEAM	INPUT VOLTAGE	HOUSING	OPERATING TEMP	LED CHIPS
ED001	6W Rechargeable LED Flare GU10 60D 3CCT Li-1400mAh	540	>80	60°	AC180V- 277V	PC & Internal Alum	0~35°C	Epistar Chips
ED002	6W Rechargeable LED Flare GU10 120D 3CCT Li-1400mAh			120°				

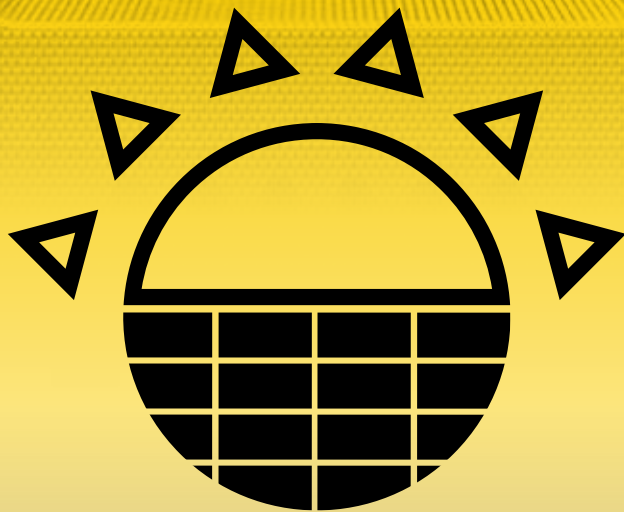

K A R U

S O L A R F L O O D L I G H T

Coming Soon



PUNCH

HIGH POWER CEILING DOWNLIGHT



HIGH POWER DOWNLIGHTERS

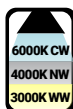

Lifud



Certificates: CE, RoHS, SAA, IEC60598, ErP

FEATURES

- **Tornado inspired reflector** designed to enhance brightness whilst effectively reducing glare with a **UGR <19**.
- Oversized Razor Cooling Fins efficiently pulling heat away from the COB LED chip giving the luminaire an **L80B10 @ 50 000hrs** rated lifespan.
- High Lumen **USA BridgeLux LED** Chip with an effective 120lm/W maximising energy savings.
- **CRI >80** allowing this product to be used in even the most delicate retail or commercial environments.
- **Quick and Easy installation/ maintenance** options with our Snap & Slide connectors seamlessly pairing the downlight & LED Power Supply.
- Robust, High Power Factor >0.9 **Flicker Free Lifud LED power supply** with a built in 2kV Surge Protection.
- **Ultra Strong Spring Back Clips** allowing for a flush clean finish once installed.

10W

6000K CW
4000K NW
3000K WW

DIM

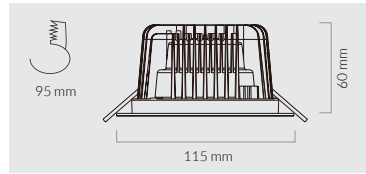

15W

6000K CW
4000K NW
3000K WW

DIM

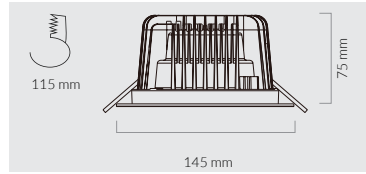

25W

6000K CW
4000K NW
3000K WW

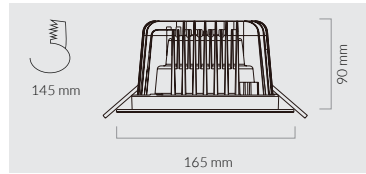

35W

6000K CW
4000K NW
3000K WW

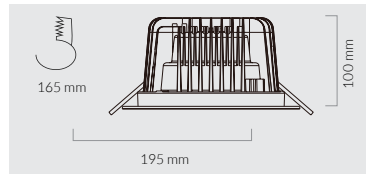

CODE	DESCRIPTION	LUMEN OUTPUT	CRI	BEAM	INPUT VOLTAGE	HOUSING	OPERATING TEMP	LED CHIPS
HD001	PUNCH LED Downlighter 10W 3000K cut 95-110 Dim	1200						
HD002	PUNCH LED Downlighter 10W 4000K cut 95-110 Dim	1200						
HD003	PUNCH LED Downlighter 10W 6000K cut 95-110 Dim	1200						
HD004	PUNCH LED Downlighter 15W 3000K cut 115-140 Dim	1800						
HD005	PUNCH LED Downlighter 15W 4000K cut 115-140 Dim	1800						
HD006	PUNCH LED Downlighter 15W 6000K cut 115-140 Dim	1800	CRI>85	55°	190V-277V	Pure Alum	-40 ~ 50°C	USA Bridgelux Chip
HD007	PUNCH LED Downlighter 25W 3000K cut 145-160	3000						
HD008	PUNCH LED Downlighter 25W 4000K cut 145-160	3000						
HD009	PUNCH LED Downlighter 25W 6000K cut 145-160	3000						
HD010	PUNCH LED Downlighter 35W 3000K cut 165-190	4200						
HD011	PUNCH LED Downlighter 35W 4000K cut 165-190	4200						
HD012	PUNCH LED Downlighter 35W 6000K cut 165-190	4200						
HD003PS	10W Punch Dim Driver							
HD006PS	15W Punch Dim Driver							
HD009PS	25W Punch non-dim Driver							
HD012PS	35W Punch non-dim Driver							

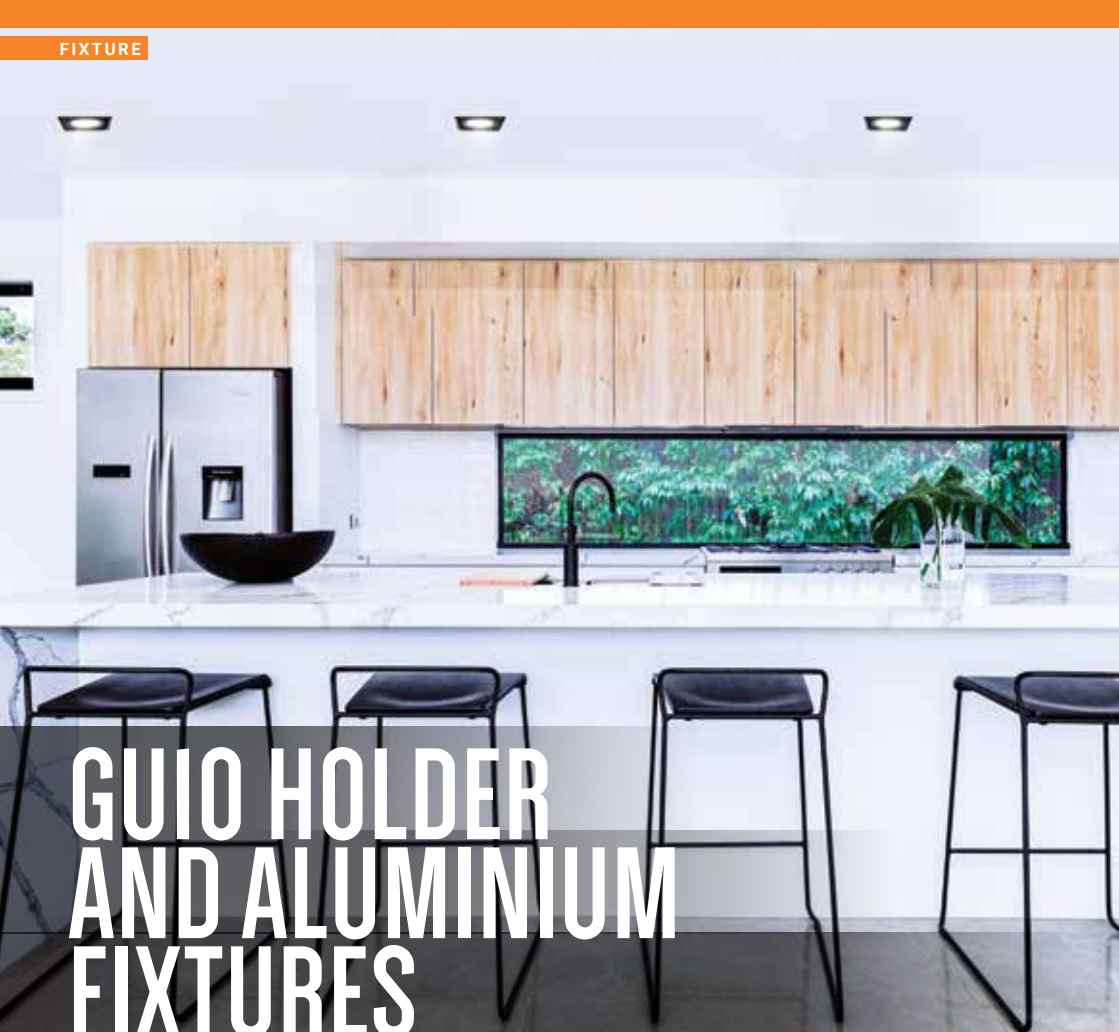

GU10 HOLDER AND ALUMINIUM FIXTURES



R101
036 - IEC GU10 Holder
 "Big junction box and terminal - easy to loop cables.
 PC cover for ceramic holder to ensure on-site safety for installers.
 CE, EMC, RoHS, ISO9001

ANTI-GLARE

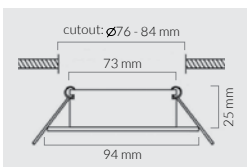

FIXED

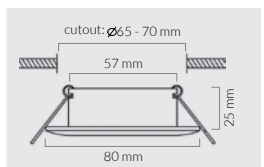

TILTS

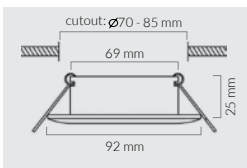

SLIM ANTI-GLARE

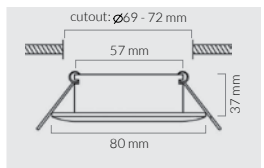

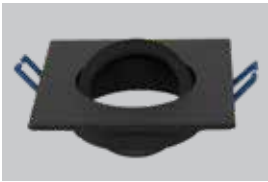

R221
Q-B5525 - AL Downlight Fixture
 Square • Black
 CNC Aluminium
 Ø92x92mm/ Cut 70 - 85

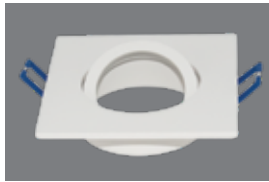

R220
Q-W5525 - AL Downlight Fixture
 Square • White
 CNC Aluminium
 Ø92x92mm/ Cut 70 - 85

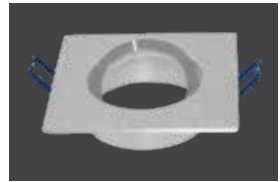

R219
Q-S5525 - AL Downlight Fixture
 Square • Silver
 CNC Aluminium
 Ø92x92mm/ Cut 70 - 85



R204
B7717 - AL Downlight Fixture
 Black • Flat • Tilt
 CNC Aluminium
 Ø92 x H25 / Cut 70 - 85



R202
W7717 - AL Downlight Fixture
 White • Flat • Tilt
 CNC Aluminium
 Ø92 x H25 / Cut 70 - 85

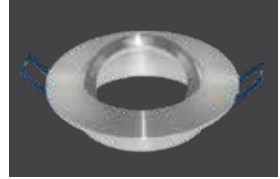

R201
S8818 - AL Downlight Fixture
 Silver • Flat • Tilt
 CNC Aluminium
 Ø92 x H25 / Cut 70 - 85



R218
BA919 - AL Downlight Fixture
 Slim Anti Glare • Black
 CNC Aluminium
 Ø80 x H37 / Cut 69 - 72



R217
WA919 - AL Downlight Fixture
 Slim Anti Glare • White
 CNC Aluminium
 Ø80 x H37 / Cut 69 - 72

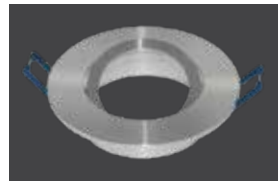

R203
S6616 - AL Downlight Fixture
 Silver • Bevelled • Tilt
 CNC Aluminium
 Ø92 x H25 / Cut 70 - 85



R216
AB928 - AL Downlight Fixture
 Anti Glare • Black
 CNC Aluminium
 Ø94 x H25 / Cut 76 - 84



R215
W-AW828 - AL Downlight Fixture
 Anti Glare • White
 CNC Aluminium
 Ø94 x H25 / Cut 76 - 84

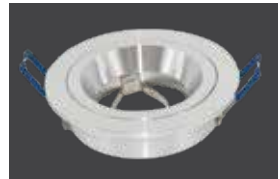

R214
S-A828 - AL Downlight Fixture
 Anti Glare • Silver
 CNC Aluminium
 Ø94 x H25 / Cut 76 - 84



R211
BN717 - AL Downlight Fixture
 Black • Flat • Fixed
 CNC Aluminium
 Ø80 x H25 / Cut 65 - 70



R212
WN717 - AL Downlight Fixture
 White • Flat • Fixed
 CNC Aluminium
 Ø80 x H25 / Cut 65 - 70

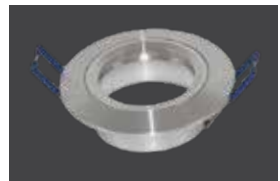

R213
SN616 - AL Downlight Fixture
 Silver • Bevelled • Fixed
 CNC Aluminium
 Ø80 x H25 / Cut 65 - 70

COASTAL FLOODLIGHTS

--	--	--	--	--	--	--	--

Certificates: CE, EMC, IEC60598, RoHS, ISO9001



Pole mount bracket available

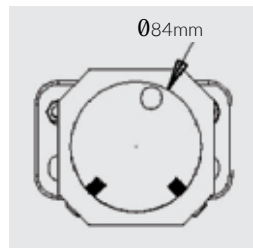

FEATURES

- High Lumen **Philips 3030** LED Chip achieving 130lm/W and 150lm/W for 500W THOR.
- Integrated IP65 constant current LED Power Supply with built in **3-10kV Surge Protection**.
- **Dynamic thermal management** design maximizing heat dissipation ultimately increase the service life of the luminaire.
- **Robust design** allows for demanding applications.
- Our Premium Range LED Floods come complete with a **1m installation cable**.
- 20 to 500W come complete with a **breather gland** reducing all forms of condensation that may occur due to harsh climatic conditions.
- Aluminium housing with anti-corrosive powder coating finish.
- **316** Stainless steel screws and bolts with **304** Stainless steel reinforced extended bracket.
- White reflector allowing for **maximum** light distribution.
- Eco-friendly alternative to HID lamps containing no mercury, lead or other harmful chemicals.
- Instant on LED Light Source.
- **50 000hr** rated service life.

20W

6000K CW
4000K NW
3000K WW

3 kV
SURGE PROTECTION

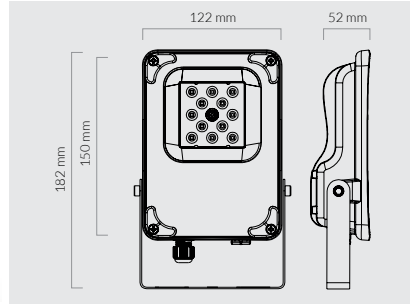

30W

6000K CW
4000K NW
3000K WW

3 kV
SURGE PROTECTION

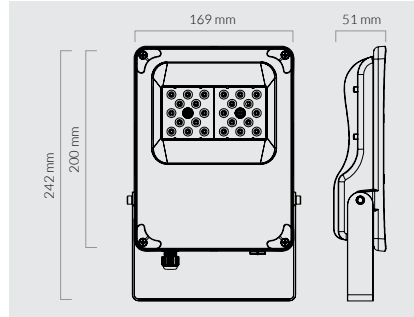

50W

6000K CW
4000K NW
3000K WW

4 kV
SURGE PROTECTION

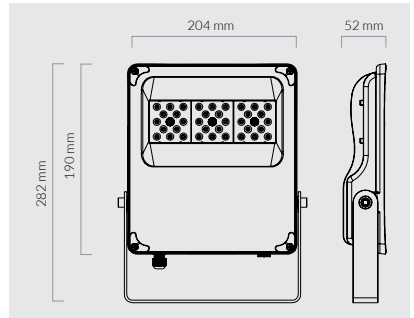

100W

6000K CW
4000K NW
3000K WW

4 kV
SURGE PROTECTION

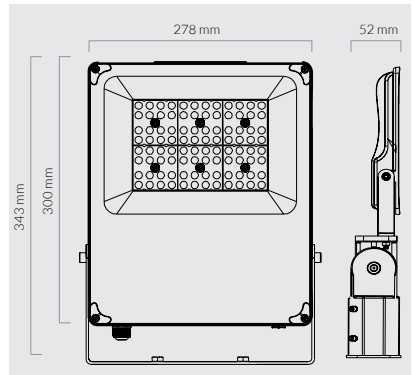

150W

6000K
(CW)

4 kV
SURGE
PROTECTION

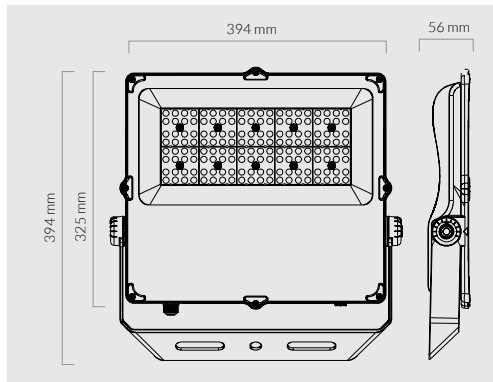

200W

6000K
(CW)

4 kV
SURGE
PROTECTION

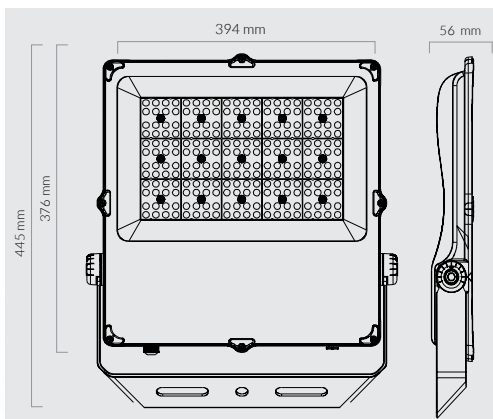

500W

6000K
(CW)

10 kV
SURGE
PROTECTION

150
LUMEN
PER WATT

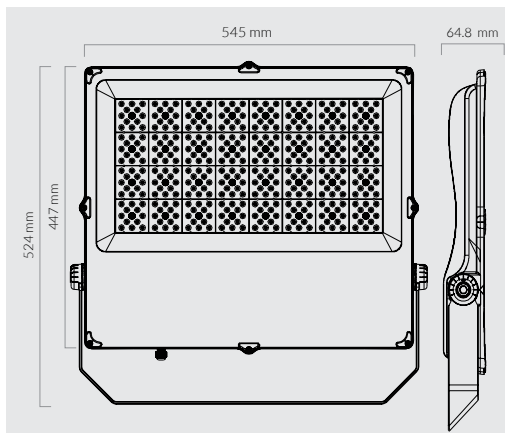

CODE	DESCRIPTION	LUMEN OUTPUT	CRI	BEAM	INPUT VOLTAGE	HOUSING	OPERATING TEMP	LED CHIPS
F103	20W THOR IP65 Coastal Heavy Duty Floodlight 6000K	2 600	>80	120D	180V- 277V	Powder Coated Alu	-30~40°C	Philips 3030
F104	20W THOR IP65 Coastal Heavy Duty Floodlight 4000K	2 600						
F105	20W THOR IP65 Coastal Heavy Duty Floodlight 3000K	2 600						
F106	30W THOR IP65 Coastal Heavy Duty Floodlight 6000K	3 900						
F107	30W THOR IP65 Coastal Heavy Duty Floodlight 4000K	3 900						
F108	30W THOR IP65 Coastal Heavy Duty Floodlight 3000K	3 900						
F109	50W THOR IP65 Coastal Heavy Duty Floodlight 6000K	6 500						
F110	50W THOR IP65 Coastal Heavy Duty Floodlight 4000K	6 500						
F111	50W THOR IP65 Coastal Heavy Duty Floodlight 3000K	6 500						
F112	100W THOR IP65 Coastal Heavy Duty Floodlight 6000K	13 000						
F113	100W THOR IP65 Coastal Heavy Duty Floodlight 4000K	13 000						
F114	100W THOR IP65 Coastal Heavy Duty Floodlight 3000K	13 000						
F116	150W THOR IP65 Coastal Heavy Duty Floodlight 6000K	19 500						
F115	200W THOR IP65 Coastal Heavy Duty Floodlight 6000K	26 000						
F118	500W THOR IP65 Coastal Heavy Duty Floodlight 6000K	75 000						
F025D	Pole Holder D84 Coastal HD 20-240W							





MODULAR LED FLOODLIGHTS



PHILIPS

Certificates: CE, EMC, IEC60958, RoHS, ISO9001

*External 10kV Surge Protectors are provided for all our Modular Floodlights from July 2022 onwards.



FEATURES

- **Marine Grade** 1100 coastal powder coated aluminium frame with 1060 pure aluminium radiating modules and hollowed out rivets serving as a heat sink.
- **316 3-part stainless steel bracket** designed to decrease installation time whilst preventing rust and corrosion.
- High Power **Philips 5050 SMD Chips** with an efficacy of 160lm/W.
- 20°/90°/140°x100° (asymmetrical beam angle) optics available. (Standard @ 90°).
- **270° rotatable bracket** with each module being able to tilt independently reducing light spillage.
- Built in **10kV surge protection** allowing for use within the most demanding environments.
- **Resistant to UV rays** with a wide operating temperature of -40°C to 50°C.

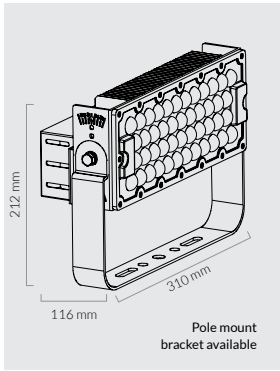
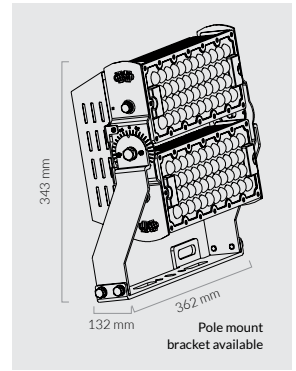
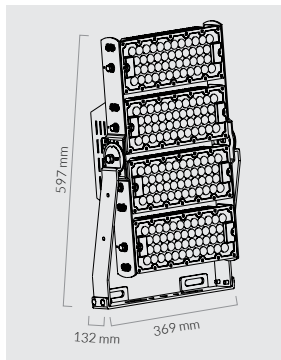
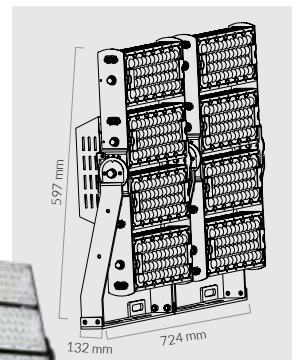
120W**5700K**
INDUSTRIAL
SPEC**240W****5700K**
INDUSTRIAL
SPEC**480W****5700K**
INDUSTRIAL
SPEC**960W****5700K**
INDUSTRIAL
SPEC

CODE	DESCRIPTION	LUMEN OUTPUT	CRI	BEAM	INPUT VOLTAGE	HOUSING	OPERATING TEMP	LED CHIPS
F028	120W IP65 Adjustable Coastal Modular Floodlights 5700K	19 200		90°				
F029	240W IP65 Adjustable Coastal Modular Floodlights 5700K	38 400		90°				
F025	480W IP65 Adjustable Coastal Modular Floodlights 5700K	76 800	>83	90°	100V- 277V	Pure Alu	-40-50°C	Philips 5050
F026	480W IP65 Adjustable Coastal Modular Floodlights 5700K	76 800		20°				
F027	960W IP65 Adjustable Coastal Modular Floodlights 5700K	153 600		90°				
F025A	20° lens							
F025B	140° 100° lens							
F027A	Screws Kit - 960W HD Floodlight Kit							
R102	IP65 10kV Surge Protection 5Amp							
R104	IP65 10kV Surge Protection 6 wire Surge Protector 8Amp							

COMBAT



IP65 COMBAT LED FLOODLIGHTS



--	--	--	--	--	--

Certificates: CE, EMC, IEC60598



FEATURES

- Die-Cast Aluminium housing with **dynamic fins** providing as an efficient and effective heatsink.
- **Driver on Board** Technology allowing for a super compact, unobtrusive LED Floodlight.
- **50cm pre wired cable** allowing for fast and easy installations.
- Pre-Installed **Safety Clips** protecting the LED Floodlights lens.
- **2835 Sanán LED Chips** producing a CRI>83.
- **120° Wide Beam Angle** allowing for maximum coverage and uniformity.
- **3kV Surge protection**, designed for use specifically in the South African Market.

7W

6000K CW
4000K NW
3000K WW

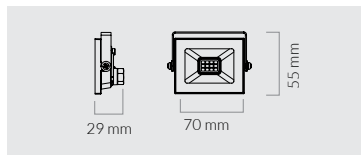

10W

3000K (WW)
6000K (CW)

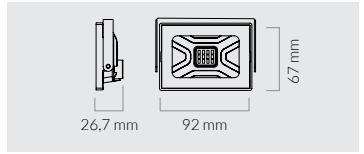

20W

3000K (WW)
6000K (CW)

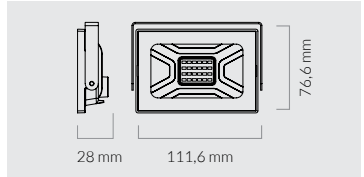

30W

3000K (WW)
6000K (CW)

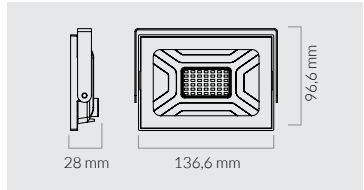

50W

3000K (WW)
6000K (CW)

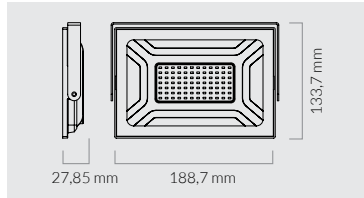

100W

6000K (CW)

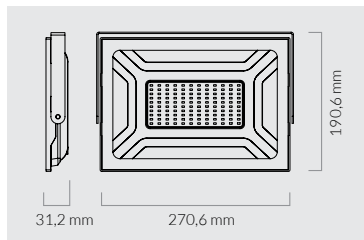

200W

6000K (CW)

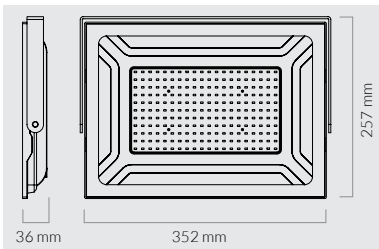



CODE	DESCRIPTION	LUMEN OUTPUT	CRI	BEAM	INPUT VOLTAGE	HOUSING	OPERATING TEMP	LED CHIPS						
F321	7W Mini IP65 Combat LED Floodlight 6000K	560	>83	120°	200V- 260V	Die-Cast Alu	-35~45°C	2835 Sanan						
F322	7W Mini IP65 Combat LED Floodlight 4000K	560												
F323	7W Mini IP65 Combat LED Floodlight 3000K	560												
F324	10W IP65 Combat LED Floodlights 6000K	800												
F326	10W IP65 Combat LED Floodlights 3000K	800												
F327	20W IP65 Combat LED Floodlights 6000K	1 600												
F329	20W IP65 Combat LED Floodlights 3000K	1 600												
F330	30W IP65 Combat LED Floodlights 6000K	2 400												
F332	30W IP65 Combat LED Floodlights 3000K	2 400												
F333	50W IP65 Combat LED Floodlights 6000K	4 000												
F336	100W IP65 Combat LED Floodlights 6000K	8 000												
F339	200W IP65 Combat LED Floodlights 6000K	16 000												
R102	IP65 10kV Surge Protection 5Amp													



COMBAT LED RGB REMOTE FLOODLIGHT



-
-
-
-
-
-

Certificates: CE, EMC, IEC60598

20W

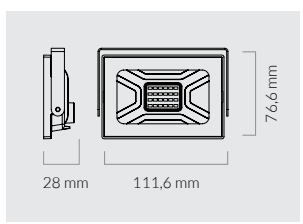

50W

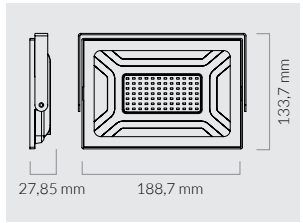

FEATURES

- RGB LED Floodlight controllable via **IR Remote Control**.
- Ultra Slim **Die-Cast Aluminium housing** with DOB tech allowing for a robust floodlight.
- Available in wattages of **20W & 50W** with a rated lifespan of 25 000hrs.
- Wide input voltage range from 200V-265V with a built in **3kV surge protection**.
- Environmentally friendly containing no mercury, lead or other harmful substances.
- **50cm pre wired cable** allowing for fast and easy installations.

CODE	DESCRIPTION	BEAM	HOUSING	INPUT VOLTAGE	OPERATING TEMP	LED CHIPS
F327RGB	20W Combat LED RGB Remote Floodlight	120°	Alu	200V- 260V	-35~45°C	SMD 2835
F333RGB	50W Combat LED RGB Remote Floodlight					
R102	IP65 10kV Surge Protection 5Amp					

COMBAT

IP65 COMBAT LED SENSOR FLOODLIGHT



Certificates: CE, EMC, IEC60598





10W 6000K (CW)

SENSOR

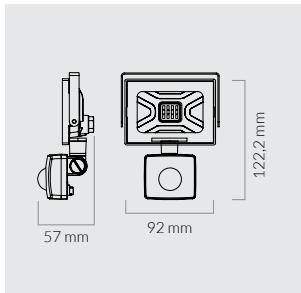

20W 6000K (CW)

SENSOR

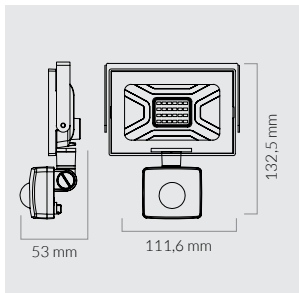

30W 6000K (CW)

SENSOR

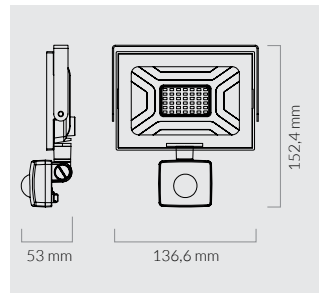

50W 6000K (CW)

SENSOR

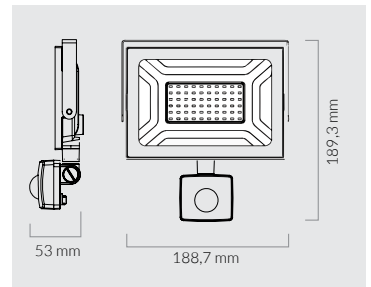

CODE	DESCRIPTION	LUMEN OUTPUT	CRI	BEAM	INPUT VOLTAGE	HOUSING	OPERATING TEMP	LED CHIPS
F324S	10W IP65 Combat LED Floodlights 6000K Sensor	800	>83	120°	200V-260V	Die-Cast Alu	-35~45°C	2835 Sanan
F327S	20W IP65 Combat LED Floodlights 6000K Sensor	1600						
F330S	30W IP65 Combat LED Floodlights 6000K Sensor	2400						
F333S	50W IP65 Combat LED Floodlights 6000K Sensor	4000						



DAY & NIGHT SENSOR FLOODLIGHT



 6000K 4000K 3000K	 PF 0.9	 3-4 kV SURGE PROTECTION	 90 LUMEN PER WATT	 2 YEAR WARRANTY
-----------------------------	---------------	--------------------------------------	-----------------------------	---------------------------

Certificates: CE, EMC, IEC60598



FEATURES

- LED floodlight with built in **Day/Night Sensor** (Turns on/off @ 10lux) for hassle free illumination.
- **DOB technology** for a sleek and compact LED floodlight.
- Built in **Breather Gland** to remove excess moisture caused by condensation.
- **Wide, 120° beam** angle for maximum coverage and uniformity.
- **1m extra length installation cable** for a quick and hassle-free installation
- Robust luminaire with a **3kV built in Surge Protection**.
- Ideal for day to day residential usage.
- Environmentally friendly containing no mercury, lead or other harmful substances.

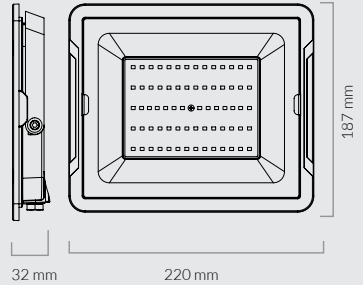
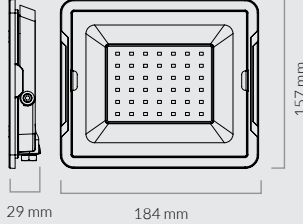
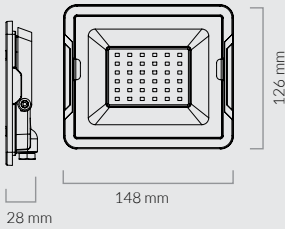

CODE	DESCRIPTION	LUMEN OUTPUT	CRI	BEAM	INPUT VOLTAGE	HOUSING	OPERATING TEMP	LED CHIPS
F504	20W Patrol Day&Night Sensor Floodlight 6000K	1 800						
F505	20W Patrol Day&Night Sensor Floodlight 4000K	1 800						
F506	20W Patrol Day&Night Sensor Floodlight 3000K	1 800						
F507	30W Patrol Day&Night Sensor Floodlight 6000K	2 700						
F508	30W Patrol Day&Night Sensor Floodlight 4000K	2 700	>83	120°	200V- 260V	Die-Cast Alu	-35~45°C	Sanan 2835
F509	30W Patrol Day&Night Sensor Floodlight 3000K	2 700						
F510	50W Patrol Day&Night Sensor Floodlight 6000K	4 500						
F511	50W Patrol Day&Night Sensor Floodlight 4000K	4 500						
F512	50W Patrol Day&Night Sensor Floodlight 3000K	4 500						
R102	IP65 10kV Surge Protection 5Amp							

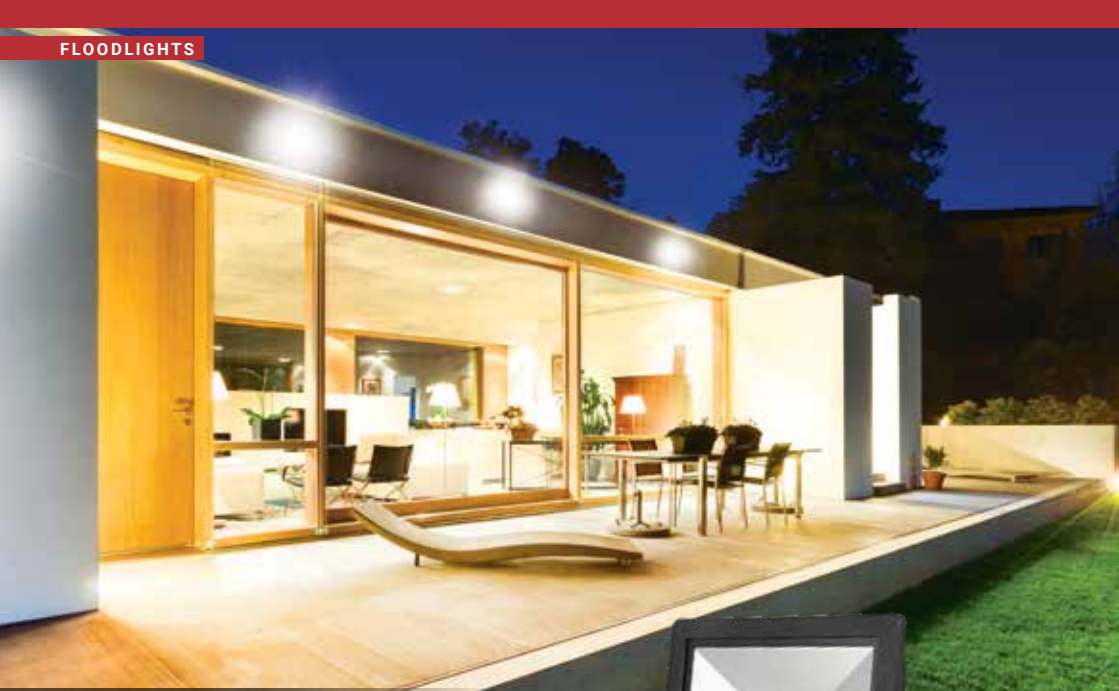

NANO FLOODLIGHTS



Certificates: CE, EMC, IEC60598

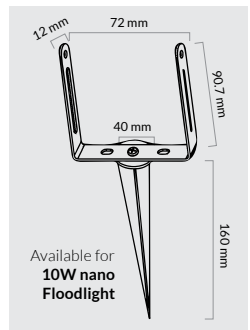

FEATURES

- **Driver on board** technology allowing for an ultra-lightweight, compact design with minimal aesthetic impact.
- Thermally tested **aluminium fins** providing as a heat sink.
- **Die Cast Aluminium** body, powder coated black with 316 Stainless Steel bolts and screws.
- All our Nano Range LED Floods come complete with a **1m installation cable**.
- **DC12V** Nano flood available in 10W.
- Garden Spike optional for 10W.
- Save up to 80% off your electrical bill as oppose to your HID lamps.
- Increase your safety with it's excellent **light output** and clarity.
- Easy to install **20° smart bracket**.
- Available in 10W/300W/500W. 20-200W are available in Nano EVO range.



10W
6000K
4000K
3000K
BLUE
GREEN
3
kV
SURGE
PROTECTION

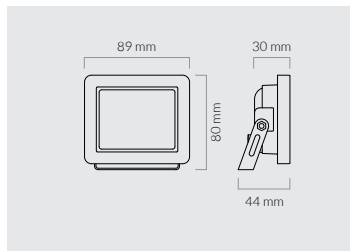

300W
6000K
(CW)
10
kV
SURGE
PROTECTION

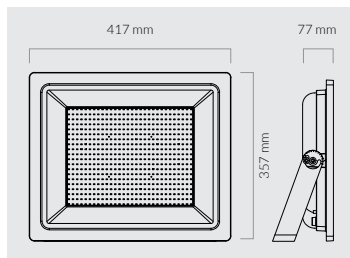

500W
6000K
(CW)
10
kV
SURGE
PROTECTION

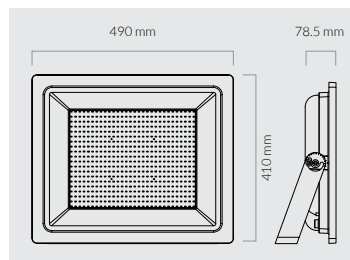

CODE	DESCRIPTION	LUMEN OUTPUT	CRI	BEAM	INPUT VOLTAGE	HOUSING	OPERATING TEMP	LED CHIPS					
F401	10W IP65 Nano LED Floodlight 6000K	750	>83	120°	200V- 260V	Die-Cast Alu	-35~45°C	2835 Sanan					
F402	10W IP65 Nano LED Floodlight 4000K	750											
F403	10W IP65 Nano LED Floodlight 3000K	750											
F419	300W IP65 Nano LED Floodlight 6000K	27 000											
F425	500W IP65 Nano LED Floodlight 6000K	45 000											
F401DC	10W IP65 Nano LED Floodlight 6000K 12V	750											
F421B	10W IP65 Nano LED Floodlight Blue												
F422G	10W IP65 Nano LED Floodlight Green												
RF001	Garden Spike and bracket for 10W Nano Flood												
R102	IP65 10kV Surge Protection 5Amp												

NANO EVO



NANO EVO FLOODLIGHTS



IP
65

PF
0.9

3-4
SURGE
PROTECTION

2
YEAR
WARRANTY

100
LUMEN
PER WATT

Certificates: CE, EMC, ErP, IEC60598



FEATURES

- **Driver on board** technology allowing for an ultra-lightweight, compact design with minimal aesthetic impact.
- Thermally tested **aluminium fins** providing as a heat sink.
- **Die Cast Aluminium** body, powder coated black with 316 Stainless Steel bolts and screws.
- All our Nano EVO Range LED Floods come complete with a **1m installation cable**.
- **DC12V** Nano flood available in 20W.
- Save up to 80% off your electrical bill as oppose to your HID lamps.
- Increase your safety with it's excellent **light output** and clarity.
- Easy to install **20° smart bracket**.
- Available in 20W-200W. 10W/300W/500W are available in Nano range.

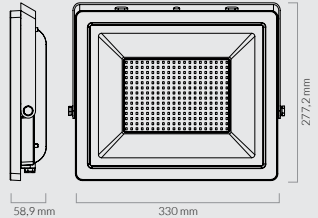
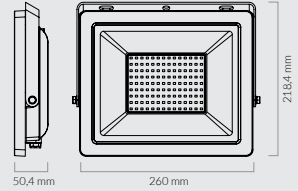
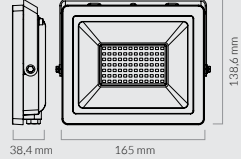
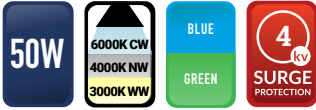
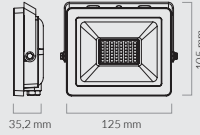
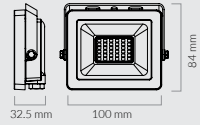

CODE	DESCRIPTION	LUMEN OUTPUT	CRI	BEAM	INPUT VOLTAGE	HOUSING	OPERATING TEMP	LED CHIPS
F4042	20W IP65 Nano EVO LED Floodlight 6000K	2 000	>83	120°	200V- 260V	Die-Cast Alu	-35~45°C	2835 Sanan
F5052	20W IP65 Nano EVO LED Floodlight 4000K	2 000						
F4062	20W IP65 Nano EVO LED Floodlight 3000K	2 000						
F4072	30W IP65 Nano EVO LED Floodlight 6000K	3 000						
F4082	30W IP65 Nano EVO LED Floodlight 4000K	3 000						
F4092	30W IP65 Nano EVO LED Floodlight 3000K	3 000						
F4102	50W IP65 Nano EVO LED Floodlight 6000K	5 000						
F4112	50W IP65 Nano EVO LED Floodlight 4000K	5 000						
F4122	50W IP65 Nano EVO LED Floodlight 3000K	5 000						
F4132	100W IP65 Nano EVO LED Floodlight 6000K	10 000						
F4152	100W IP65 Nano EVO LED Floodlight 3000K	10 000						
F4162	200W IP65 Nano EVO LED Floodlight 6000K	20 000						
F4022DC	20W IP65 Nano EVO LED Floodlight 6000K 12V	2 000						
F4272B	50W IP65 Nano EVO LED Floodlight Blue							
F4282G	50W IP65 Nano EVO LED Floodlight Green							



NANO EVO SENSOR FLOODLIGHTS



IK
07

IP
65/44

PF
0.9

3-4
SURGE
PROTECTION

2
YEAR
WARRANTY

6000K
(CW)

Certificates: CE, EMC, ErP, IEC60598



CODE	DESCRIPTION	LUMEN OUTPUT	CRI	BEAM	INPUT VOLTAGE	HOUSING	OPERATING TEMP	LED CHIPS
F401S	Sensor 10W IP65 Nano LED Floodlights 6000K	750	>83	120°	200V- 260V	Die-Cast Alu	-35~45°C	2835 Sanan
F4022S	Sensor 20W IP65 Nano EVO LED Floodlights 6000K	2 000						
F4072S	Sensor 30W IP65 Nano EVO LED Floodlights 6000K	3 000						
F4102S	Sensor 50W IP65 Nano EVO LED Floodlights 6000K	5 000						

NANO



10W

6000K (CW)

3 kV SURGE PROTECTION

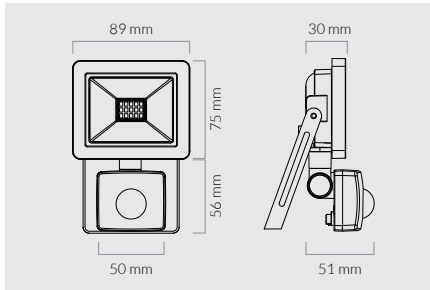

NANO



20W

6000K (CW)

3 kV SURGE PROTECTION

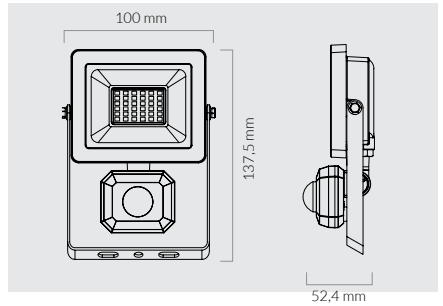

NANO



30W

6000K (CW)

3 kV SURGE PROTECTION

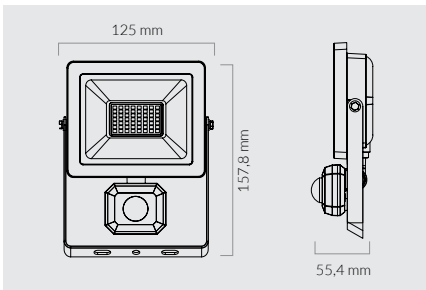

NANO



50W

6000K (CW)

4 kV SURGE PROTECTION

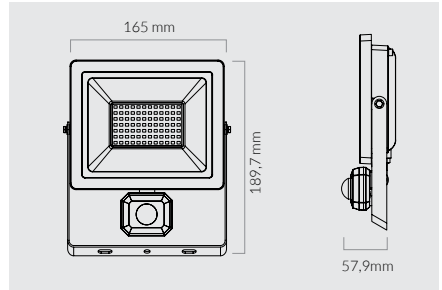

Back-lit



LED PANELS

1200 x 600 | 600 x 600 | 1200 x 300

FLICKER
FREEPF
0.9SURGE
PROTECTIONLUMEN
PER WATTL80B10
50000 hrs5
YEAR
WARRANTY

DIM

3 CCT
THREE
COLOUR
IN ONEIP
406000K
5000K
4000K4000K
5000K
6000K

Certificates: IEC60598, TUV, CE, EMC, LVD, SAA, RoHS, SO9001

FEATURES

- Backlit LED Panel providing continuous lighting **without the flickering** commonly found in fluorescent variants.
- Lightweight construction allowing for a quick and easy **one-man installation**.
- Fits into standard 600 x 600 / 1200 x 600 ceiling tiles adding to the quick installation.
- Backlit LED Technology **evenly diffuses** the 2835 SMD LED Chips without creating any darkspots.
- **High PF>0.9** External LED Driver with a wide Voltage range of 185-277V.
- Our Backlit Panels will **not yellow or discolour** after extended usage.
- 120° wide beam angle allowing for maximum surface area coverage whilst delivering over **100lm/W**.
- **Dimmable/Dali** optional.

CODE	DESCRIPTION	LUMEN OUTPUT	CRI	BEAM	INPUT VOLTAGE	HOUSING	OPERATING TEMP	LED CHIPS
iB101	40W Backlit LED 600X600 Panel Light 6000K	4 000						
iB102	40W Backlit LED 600X600 Panel Light 4000K	4 000						
iB103	40W Backlit LED 600X600 Panel Light 3CCT	4 000						
iB104	60W Backlit LED 600X1200 Panel Light 6000K	6 000						
iB105	60W Backlit LED 600X1200 Panel Light 4000K	6 000	>83	120°	185V- 277V	Alu	-20~40°C	2835 Sanan
iB106	60W Backlit LED 600X1200 Panel Light 3CCT	6 000						
iB107	40W Backlit LED 1200X300 Panel Light 3CCT	4 000						
iB603	3x12 Back-Lit H65 Surface Mount Case							
iB606	6x6 Back-Lit H65 Surface Mount Case							
iB612	12x6 Back-Lit H65 Surface Mount Case							
R111	5Amp 3M Cordset							
R113	5Amp 2M Cordset							
i6061	6x6 hanging kit - 1M x 4							
i6121	6x12 hanging kit - 1M x 6							

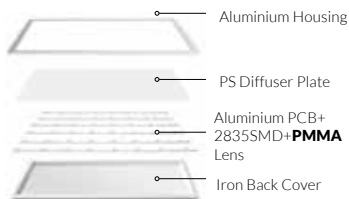
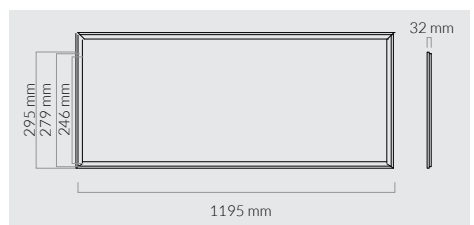
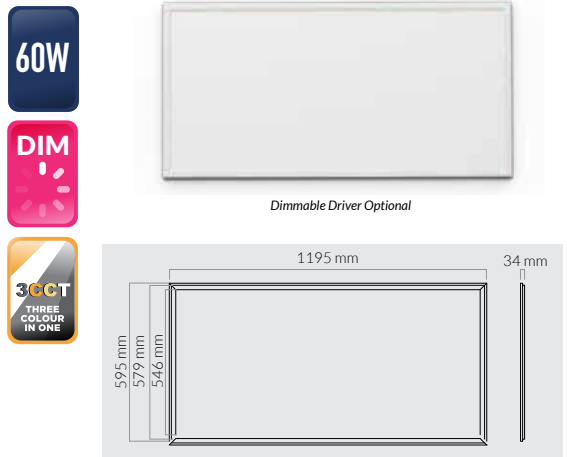
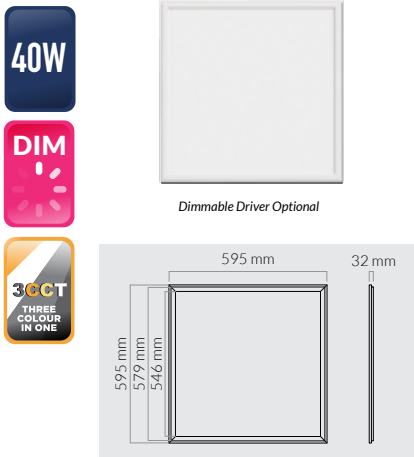

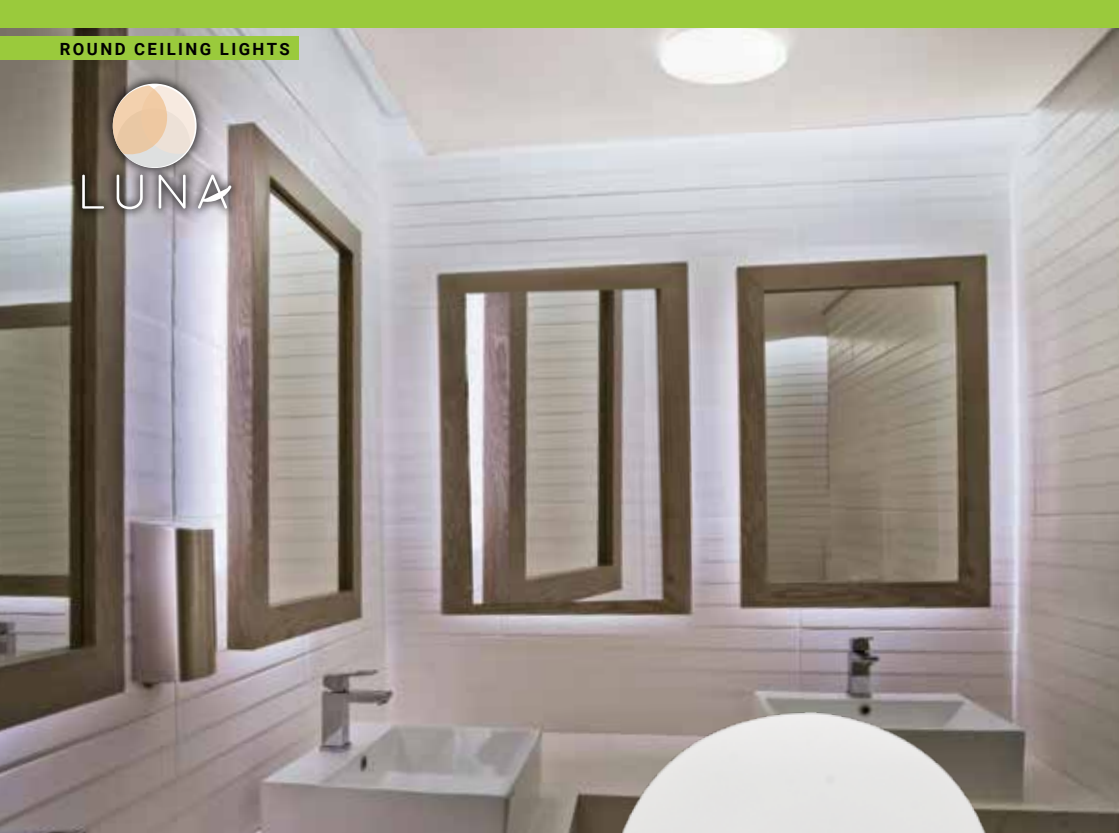

3CCT ROUND CEILING LIGHT



Certificates: CE, EMC, IEC60598

FEATURES

- IP33 Ceiling Light providing a durable, economic LED solution.
- Body consists of an **aluminium PCB, metal housing** and a **PMMA diffuser**.
- **120° Wide beam** angle ceiling light designed to cover large surface areas with maximum uniformity.
- Frosted diffuser creating a **soft uniform light distribution** eliminating any visuals of the raw SMD LED
- Built in **CCT Dipswitch** allowing seamless transitions between 3000K/4000K/6000K.
- The Ideal product for day to day, residential usage
- Environmentally friendly containing no mercury, lead or other harmful substances.

BUILT-IN **DIP SWITCH** FOR CCT CHANGING

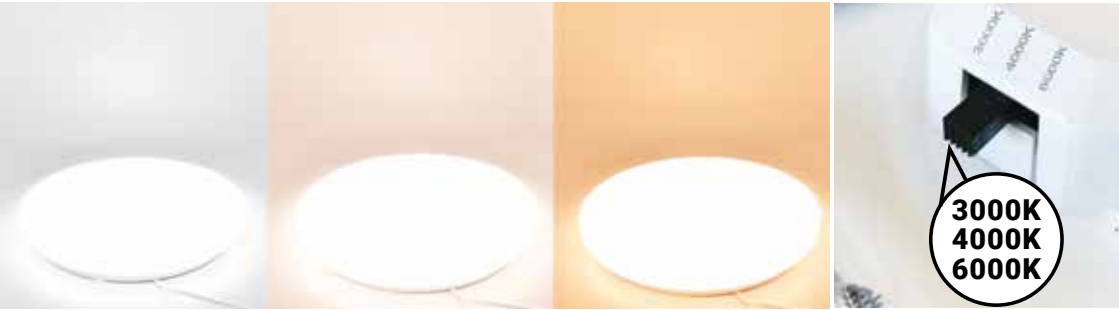

12W

3CCT
THREE COLOUR
IN ONE

∅255

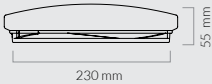
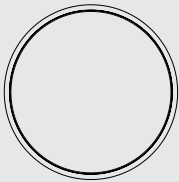

230 mm



18W

3CCT
THREE COLOUR
IN ONE

∅310

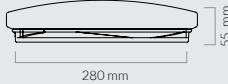
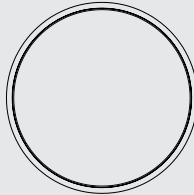

280 mm



24W

3CCT
THREE COLOUR
IN ONE

∅350

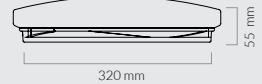
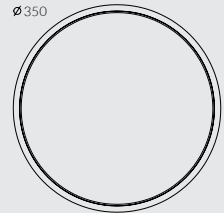

320 mm

CODE	DESCRIPTION	LUMEN OUTPUT	CRI	BEAM	INPUT VOLTAGE	HOUSING	OPERATING TEMP	LED CHIPS
iC001	12W IP33 Luna 3CCT Round Ceiling Light 3CCT	1 000						
iC002	18W IP33 Luna 3CCT Round Ceiling Light 3CCT	1 500	>80	120°	180V- 265V	Alu PCB + Metal housing	-20~40°C	Sanan 2835
iC003	24W IP33 Luna 3CCT Round Ceiling Light 3CCT	2 000						



LED RECESSED ROUND CEILING LIGHTS



Certificates: CE, EMC, IEC60598, TUV, LVD, SAA, RoHS, ISO9001



High Spec
PioLED
Driver



Dimmable
Driver
Optional



FEATURES

- **Ultra Slim** Maintenance Free LED Downlight.
- Frosted **polycarbonate diffuser** allowing for uniform light distribution.
- **Pure Aluminium** housing for excellent thermal management.
- **Dimmable / Dali** Optional.
- Available in 3000K/4000K/6000K.
- **Sanan SMD LED** Chips.
- Instant on **flicker free LED Driver**.
- Ideal for offices, hospitals, schools, corridors etc.
- High Power Factor, low THD driver.
- **1.5kV Built in Surge Protection**.
- Short Circuit Protection, Over Current Protection, Over Voltage Protection, Under Voltage Protection, Over Temperature Protection.
- **3mm PMMA Light Guide** preventing dark spots and yellowing through extended usage.

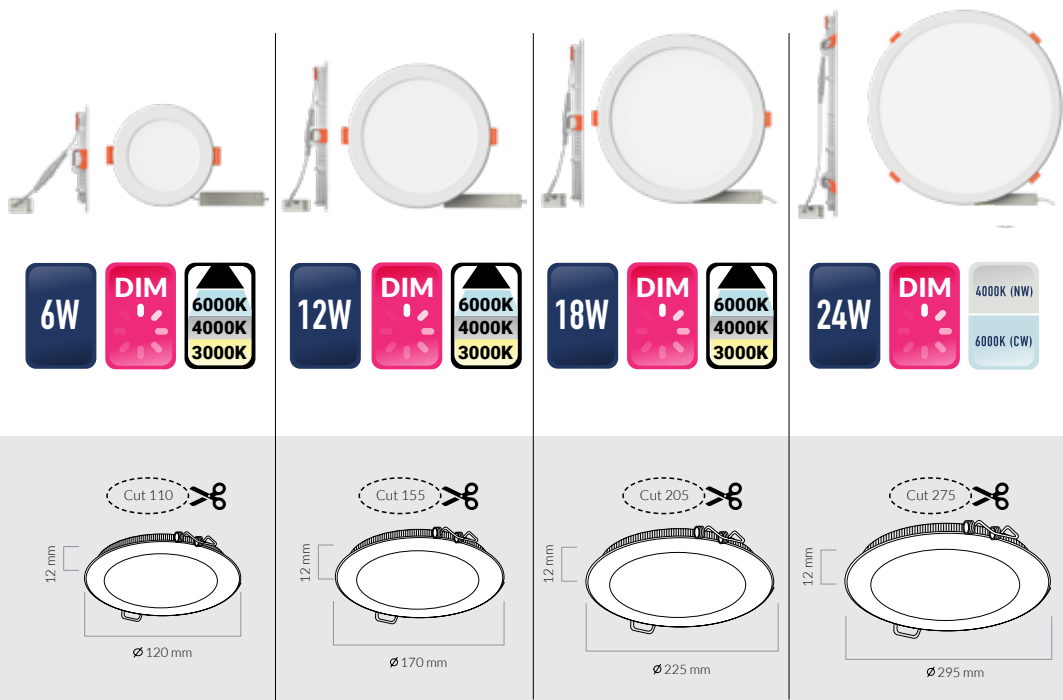

CODE	DESCRIPTION	LUMEN OUTPUT	CRI	BEAM	INPUT VOLTAGE	HOUSING	OPERATING TEMP	LED CHIPS
i003	6W LED Round Recessed Panel Light 6000K	460	>83	120°	185V- 277V	Alu	-20-45°C	2835 Sanan
i004	6W LED Round Recessed Panel Light 4000K	460						
i005	6W LED Round Recessed Panel Light 3000K	460						
i006	12W LED Round Recessed Panel Light 6000K	1080						
i007	12W LED Round Recessed Panel Light 4000K	1080						
i008	12W LED Round Recessed Panel Light 3000K	1080						
i009	18W LED Round Recessed Panel Light 6000K	1710						
i010	18W LED Round Recessed Panel Light 4000K	1710						
i011	18W LED Round Recessed Panel Light 3000K	1710						
i012	24W LED Round Recessed Panel Light 6000K	2300						
i013	24W LED Round Recessed Panel Light 4000K	2300						
i003Di	6W Dimmable Driver for Round Recessed Panel							
i006Di	12W Dimmable Driver for Round Recessed Panel							
i009Di	18W Dimmable Driver for Round Recessed Panel							
i012Di	24W Dimmable Driver for Round Recessed Panel							

IRIS

Recessed & Surface in 1

LED 2 IN 1 ROUND CEILING LIGHTS



Certificates: CE, EMC, IEC60598, TUV, LVD, SAA, RoHS, ISO9001



FEATURES

- **Thermal Plastic** housing coupled with internal aluminium providing as the heat sink.
- **Driver on board** technology allowing for an ultra slim aesthetically pleasing luminaire at only **15 mm** thick.
- **Surface mount** or **Recessed mount** with its uniquely adjustable clips – Can cover square or round existing ceiling holes.
- **Flicker Free** technology making it the ideal luminaire for offices or specialized environments.
- Matt Black or Satin Nickel Magnetic Trims optional.
- **CCT Adjustable** and **dimmable** options available.
- Extremely **quick installation**.

6W
3CCT
THREE
COLOUR
IN ONE

DIM
6000K
4000K
3000K

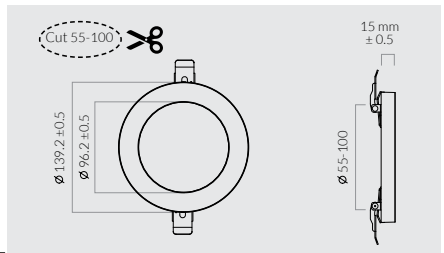
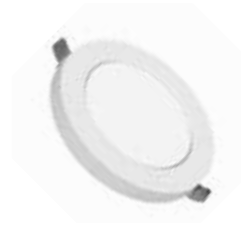

12W
3CCT
THREE
COLOUR
IN ONE

DIM
6000K
4000K
3000K

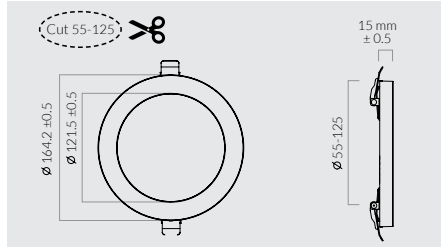

18W
3CCT
THREE
COLOUR
IN ONE

DIM
6000K
4000K
3000K

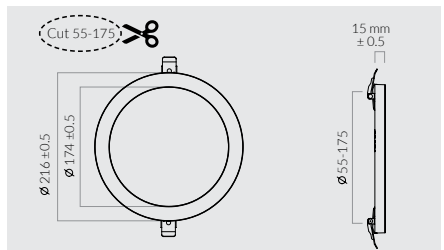

24W
3CCT
THREE
COLOUR
IN ONE

DIM
6000K
4000K
3000K

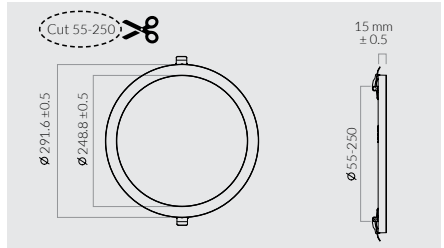

3CCT SWITCH
FOR DIM IRIS

MATT BLACK

Available for 6W,
12W, 18W and 24W

SATIN NICKEL

Available for
6W, 12W, 18W
and 24W

IRIS
TRIM

ONLY
15mm THICK



ROUND CEILING LIGHTS

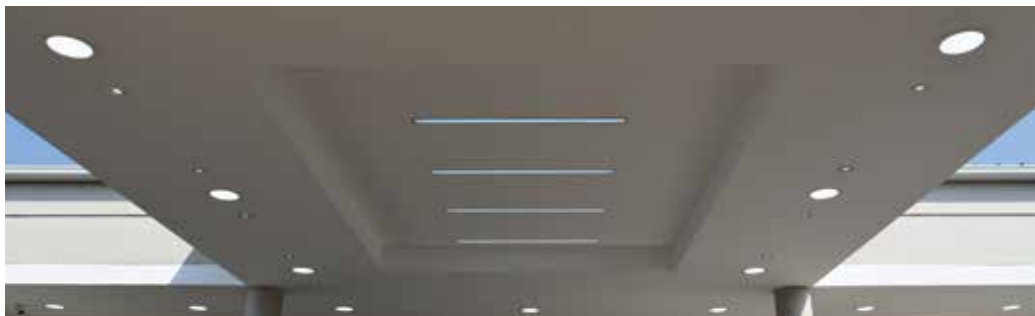

CODE	DESCRIPTION	LUMEN OUTPUT	CRI	BEAM	INPUT VOLTAGE	HOUSING	OPERATING TEMP	LED CHIPS						
i023	6W IRIS LED Surface/Recessed Round Panel Light 6000K	455	>83	120°	200V- 265V	PC & Internal Alu	-20~40°C	2835 Sanan						
i024	6W IRIS LED Surface/Recessed Round Panel Light 4000K	455												
i025	6W IRIS LED Surface/Recessed Round Panel Light 3000K	455												
i026	12W IRIS LED Surface/Recessed Round Panel Light 6000K	1 050												
i027	12W IRIS LED Surface/Recessed Round Panel Light 4000K	1 050												
i028	12W IRIS LED Surface/Recessed Round Panel Light 3000K	1 050												
i029	18W IRIS LED Surface/Recessed Round Panel Light 6000K	1 600												
i030	18W IRIS LED Surface/Recessed Round Panel Light 4000K	1 600												
i031	18W IRIS LED Surface/Recessed Round Panel Light 3000K	1 600												
i032	24W IRIS LED Surface/Recessed Round Panel Light 6000K	2 250												
i033	24W IRIS LED Surface/Recessed Round Panel Light 4000K	2 250												
i034	24W IRIS LED Surface/Recessed Round Panel Light 3000K	2 250												
i041	6W IRIS & DIM LED Surface/Recessed Round Panel Light 3CCT	455												
i042	12W IRIS & DIM LED Surface/Recessed Round Panel Light 3CCT	1 050												
i043	18W IRIS & DIM LED Surface/Recessed Round Panel Light 3CCT	1 600												
i044	24W IRIS & DIM LED Surface/Recessed Round Panel Light 3CCT	2 250												
i092r	6W Exchangeable Trim for IRIS Black													
i093r	12W Exchangeable Trim for IRIS Black													
i094r	18W Exchangeable Trim for IRIS Black													
i095r	24W Exchangeable Trim for IRIS Black													
i096r	6W Exchangeable Trim for IRIS Satin Nickel													
i097r	12W Exchangeable Trim for IRIS Satin Nickel													
i098r	18W Exchangeable Trim for IRIS Satin Nickel													
i099r	24W Exchangeable Trim for IRIS Satin Nickel													

HELIOS

IP65 UFO
HIGHBAY

Certificates: CE, EMC, IEC60598, SAA



Standard safety buckle
& 1m safety string
(Max 35kg)

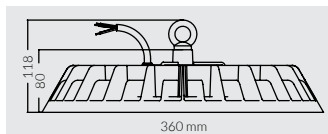
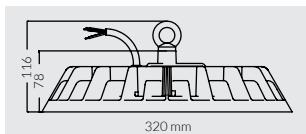
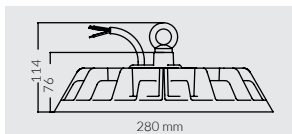

FEATURES

- Excellent Thermal Performance with our **Multi-circulation Aluminum Cooling Fins**.
- Ultra **High Lumen Lumileds LED Chips** delivering an effective 140lm/W.
- Industrial Grade Components with a **4kV surge protection** designed to increase longevity in even the harshest environments.
- Complimentary **1m hanging kit** and **1m installation cable (from Batch 2210)** provided ensuring a Hassle Free installation.
- **High CRI>83** for maximum clarity & colour rendering.
- **90D Beam Angle** allowing for maximum surface coverage whilst still providing enhanced illumination.
- Available in **Industrial Spec Cool White 5700K**.

CODE	DESCRIPTION	LUMEN OUTPUT	CRI	BEAM	INPUT VOLTAGE	HOUSING	OPERATING TEMP	LED CHIP
HB401	100W Helios IP65 UFO Highbay 5700K	14 000						
HB404	150W Helios IP65 UFO Highbay 5700K	21 000	>83	90°	180V-277V	Pure Alum	-20~40°C	Lumileds LED Chips
HB407	200W Helios IP65 UFO Highbay 5700K	28 000						



3 IN 1 DIMMABLE HIGHBAY

--	--	--	--	--	--	--	--

Certificates: CE, EMC, IEC60598

L80B10
50000 hrs



Standard safety buckle & 1m safety string (Max 35kg)



Surface Mount Bracket (3CR12) Optional



FEATURES

- Powered by the Robust **3 IN 1 Dimmable** Sosen LED Driver(1-10V, PWM, Resistance).
- High Lumen **Philips 2835 SMD** LED Chips delivering 150lm/W.
- Wide Voltage Range 90V-305V with a **4kV Built in surge protection.**
- Standard Beam angle of 90° with optional beam angles of 60° & 120°.
- TM21, **L80B10 @ 50 000hrs.**
- High CRI LED Chips with an **Anti-Glare reflector** designed for maximum eye comfort in demanding applications.
- Available in Industrial Spec 5700K or 4000K.
- Wide operating temperature range from **-40°C ~ 50°C.**
- Suspension or Bracket mount optional

100W
4000K (NW)
5700K
INDUSTRIAL SPEC

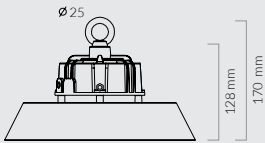
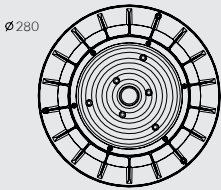

160W
4000K (NW)
5700K
INDUSTRIAL SPEC

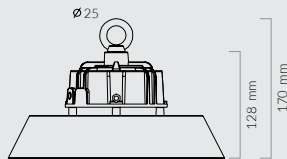
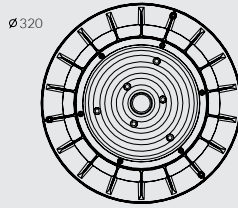

200W
4000K (NW)
5700K
INDUSTRIAL SPEC

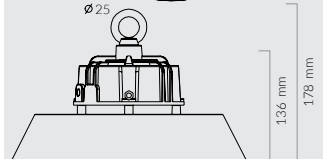
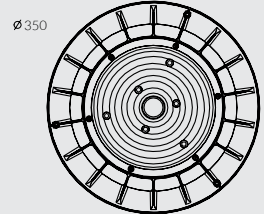

CODE	DESCRIPTION	LUMEN OUTPUT	CRI	BEAM	INPUT VOLTAGE	HOUSING	OPERATING TEMP	LED CHIPS
HB301	100W Samurai IP65 UFO Floodlight 5700K	15 000		90°				
HB301D2	100W Samurai IP65 UFO Floodlight 5700K	15 000		120°				
HB302	100W Samurai IP65 UFO Floodlight 4000K	15 000		90°				
HB302D2	100W Samurai IP65 UFO Floodlight 4000K	15 000		120°				
HB304	160W Samurai IP65 UFO Floodlight 5700K	24 000		90°				
HB304D2	160W Samurai IP65 UFO Floodlight 5700K	24 000	>83	120°	90V-305V	Alu	-40~50°C	Philips 2835
HB305	160W Samurai IP65 UFO Floodlight 4000K	24 000		90°				
HB307	200W Samurai IP65 UFO Floodlight 5700K	30 000		90°				
HB307D2	200W Samurai IP65 UFO Floodlight 5700K	30 000		120°				
HB308	200W Samurai IP65 UFO Floodlight 4000K	30 000		90°				
HB301a	Bracket for 100W							
HB304a	Bracket for 160W							
HB307a	Bracket for 200W							
HB301b	60D Lens for 100W							
HB304b	60D Lens for 160W							
HB307b	60D lens for 200W							
HB301c	120D lens for 100W							



160W HEAVY DUTY UFO HIGHBAY



Certificates: CE, EMC, RoHS, ISO9001



L80B10
50000 hrs

PHILIPS



FEATURES

- **Meanwell** IP65 constant current driver with **6kV Built in Surge Protection**.
- **High Lumen Philips** LED Chips delivering an impressive **170lm/W**.
- **Suspension** or **Bracket** mount options.
- 90° standard beam angle with a 120° optic optional.
- **High CRI**, smooth and even light distribution increasing visibility, safety and clarity reducing unnecessary workplace injuries.
- **IP65 rated luminaire** allowing for excellent performance in even the toughest environments.
- **Eco friendly** alternative to HID lamps containing no mercury, lead or harmful chemicals.
- Eliminates the need for unnecessary annual/bi-annual lamp and ballast replacement costs.
- Thermally tested to ensure ample **heat dissipation** increasing longevity of the luminaire.
- Expertly positioned **aluminium fins** designed to increase durability and performance.
- Short Circuit Protection, Over Current Protection, Over Voltage Protection, Under Voltage Protection, Over Temperature Protection.
- Optimal performance in Warehouses, Halls, Gyms, Churches, Panel Beaters etc.

160W

5700K
INDUSTRIAL
SPEC

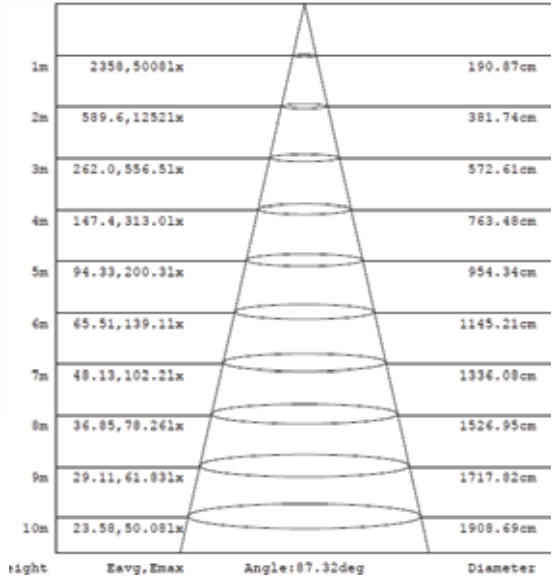
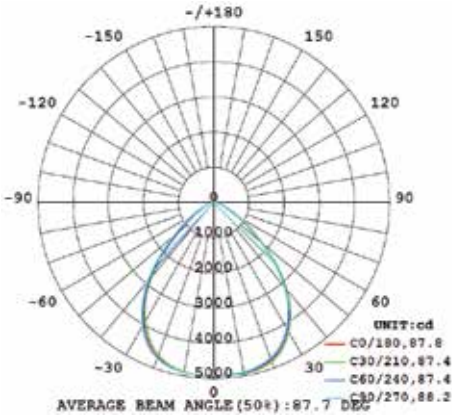
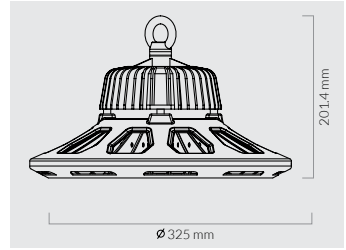

CODE	DESCRIPTION	LUMEN OUTPUT	CRI	BEAM	INPUT VOLTAGE	HOUSING	OPERATING TEMP	LED CHIPS
HB003	160W Heavy Duty IP65 UFO Floodlight 5700K	27 200	>83	120°	85V- 277V	Alu Heat Fins	-40~40°C	Philips 3030
HB004	160W Heavy Duty IP65 UFO Floodlight 5700K			90°				
HB004A	120° Lens							
HB004C	Mounting Bracket Optional							

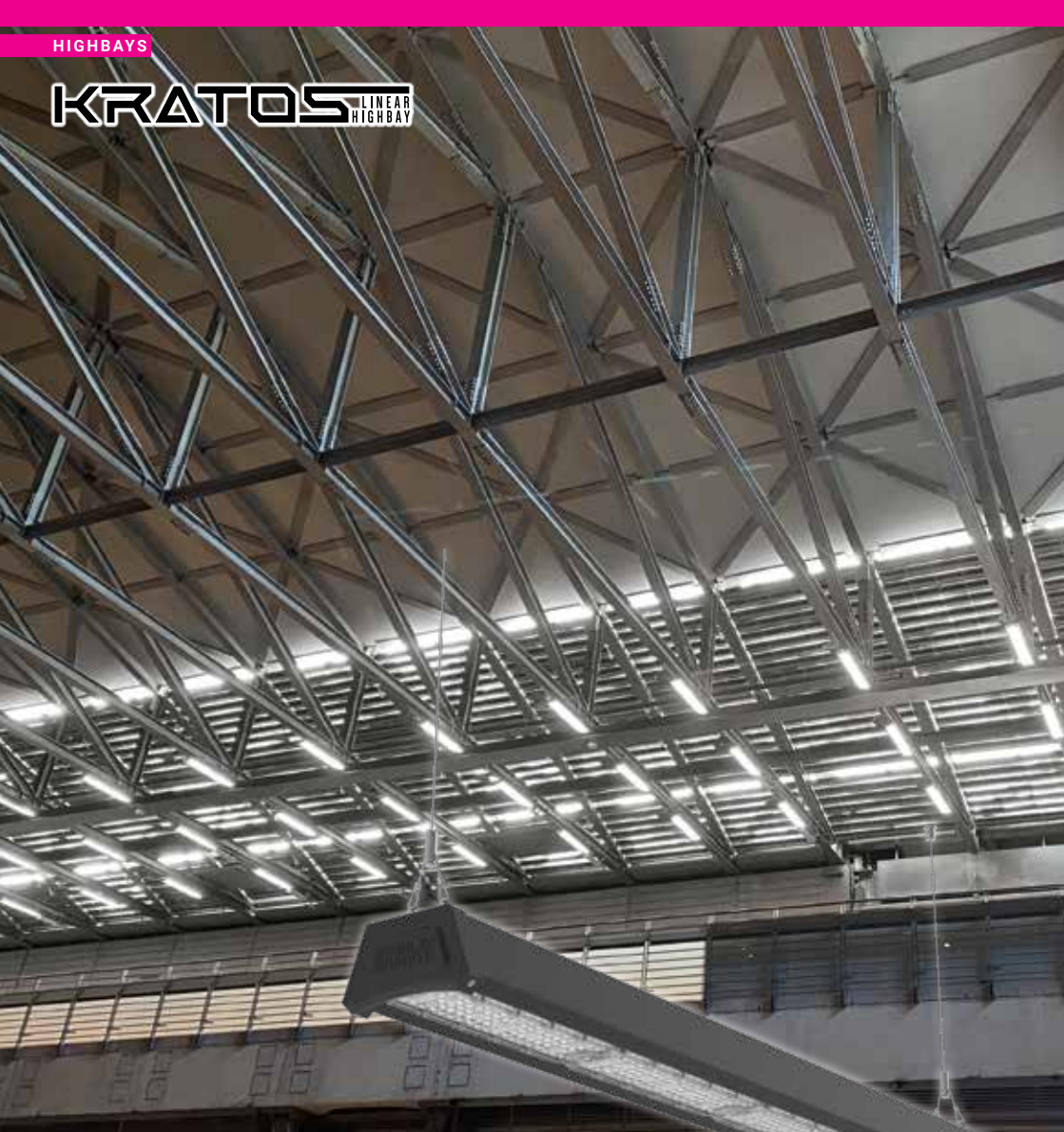

LINEAR HIGHBAY



Certificates: CE, IEC60598, EMC, ErP, TM21



FEATURES

- **Industrial Spec** Philips 5700K LED Chips producing an effective 140lm/W.
- Specially designed optics **30°x90° or 90°** available, the ultimate solution for high racking warehouse installations.
- Pure Aluminium **Matt Black Powder Coated** Housing providing quick and efficient heat dissipation.
- **1-10V Dimmable Driver** with a built in **4kV Surge Protection** for hassle free illumination.
- **L80B10** @ 50 000 hours rated lifespan ensures maximum lumen output with minimal decay.
- Ideal for Cold rooms and Standard warehousing applications with a Working Temperature of **-20°C ~ 40°C**.
- **IK08 Impact Resistance** increasing the robustness of the luminaire.
- **Suspension Kit** included for a quick and easy installation.

CODE	DESCRIPTION	LUMEN OUTPUT	CRI	BEAM	INPUT VOLTAGE	HOUSING	OPERATING TEMP	LED CHIP
HBL001	100W Kratos IP54 Linear Highbay 5700K 30°x90°	14 000	>80	30°x90°	100-277V	Alu	-20~40°C	Philips 2835
HBL002	100W Kratos IP54 Linear Highbay 5700K 90°	14 000		90°				
HBL007	150W Kratos IP54 Linear Highbay 5700K 30°x90°	21 000		30°x90°				
HBL008	150W Kratos IP54 Linear Highbay 5700K 90°	21 000		90°				
HBL013	200W Kratos IP54 Linear Highbay 5700K 30°x90°	28 000		30°x90°				
HBL014	200W Kratos IP54 Linear Highbay 5700K 90°	28 000		90°				

100W
5700K
INDUSTRIAL
SPEC

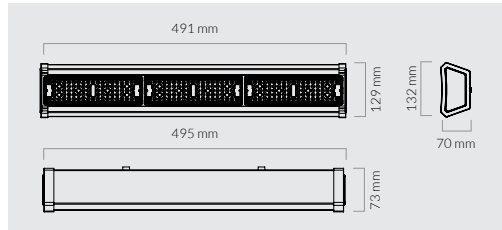

150W
5700K
INDUSTRIAL
SPEC

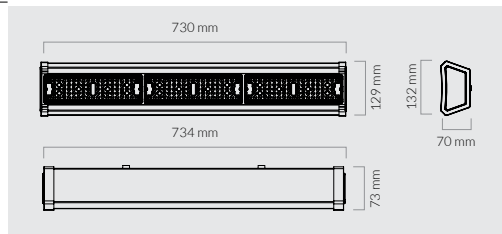

200W
5700K
INDUSTRIAL
SPEC

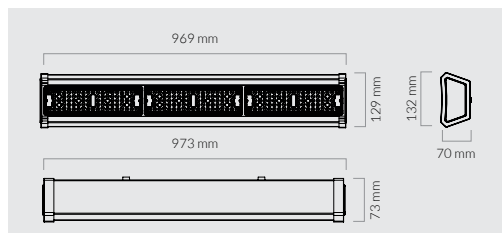



RETROFIT MODULES



Certificates: RoHS, ISO9001

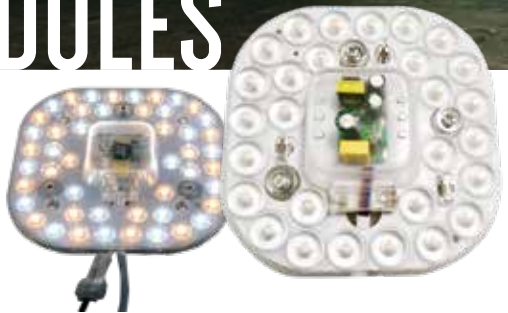

FEATURES

- Magnetic housing provides as a quick and easy **LED retrofit** to existing bulkhead luminaires.
- Built in **1mm aluminium plate** designed to dissipate heat whilst improving the LED Lifespan.
- **Heat resistant** PC lens increasing durability.
- **120° wide beam** angle allowing for maximum surface area coverage.
- LED Module takes **direct 220V** eliminating the need for external LED Drivers.
- 2835 SMD LED Chips delivering **110lm/W**.
- Environmentally friendly alternative containing no mercury, lead or other harmful chemicals.
- **1kV surge protection**.

CODE	DESCRIPTION	LUMEN OUTPUT	CRI	BEAM	INPUT VOLTAGE	HOUSING	OPERATING TEMP	LED CHIPS
iM028	14W LED Retrofit Module 6000K	1540						
iM029	18W LED Retrofit Module 6000K	1980	>83	120°	200V-277V	PC Lens + 1mm Alu	-20~40°C	2835 Sanan
iM102	14W LED Retrofit Module 3CCT	1540						
iM101	18W LED Retrofit Module 3CCT	1980						

BUILT-IN DIP SWITCH FOR CCT CHANGING

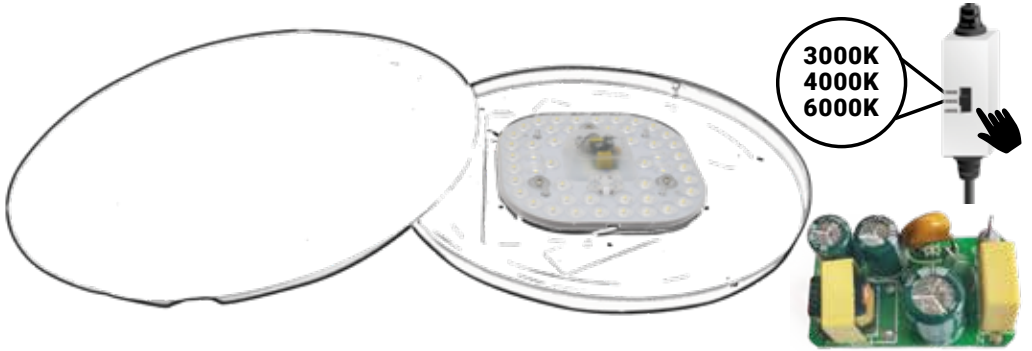

14W

6000K (CW)

3CCT
THREE COLOUR IN ONE



18W

6000K (CW)

3CCT
THREE COLOUR IN ONE

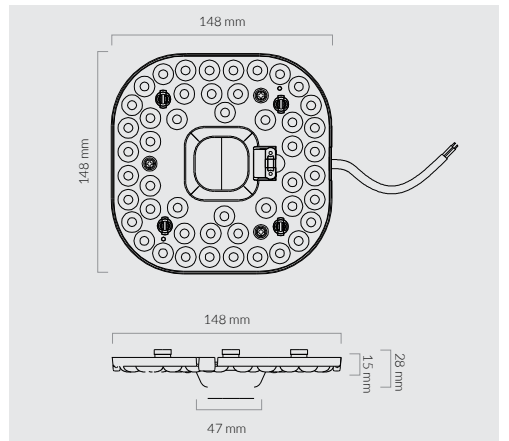
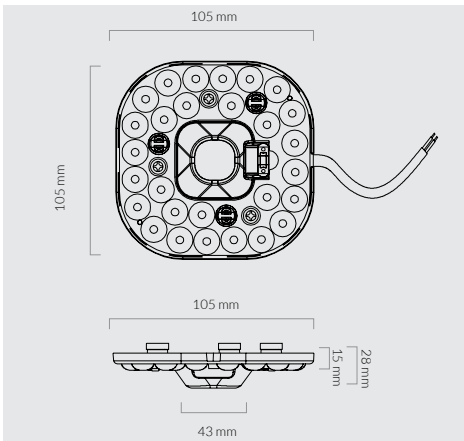

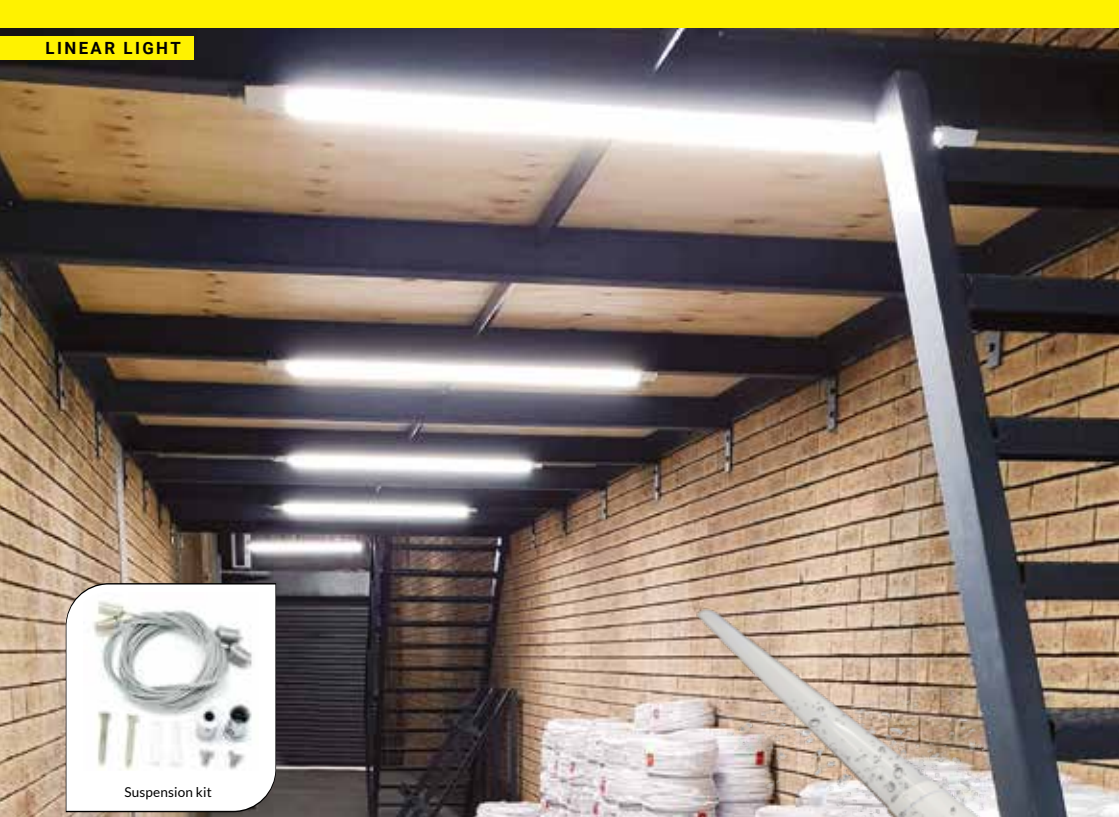

Suspension kit

IP65 SUPER SLIM LINEAR LIGHT



Certificates: CE, EMC, IEC60598

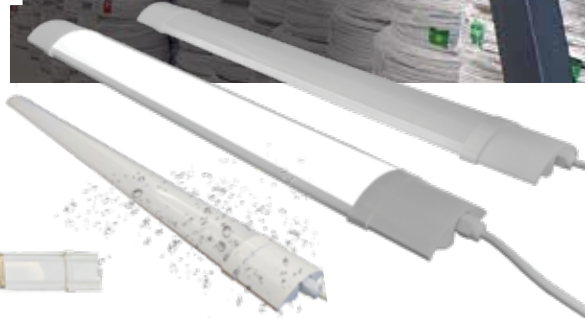

FEATURES

- High quality **Coastal Grade** PC body preventing rust and corrosion.
- **Internal Aluminium** providing as an optimal heat sink.
- **Ultra Slim** design with a total height of 22mm.
- **Opal diffuser** allowing for a uniform light output with minimal glare.
- **Equivalent to 2 x fluorescent tubes** in a vapour proof fitting.
- Operating temperature: **-20°C to 45°C**.
- Highly efficient SMD LED Chips with an effective lumen output of up to **90lm/W**.
- **120° Wide Beam** Angle increasing surface area coverage.
- Complete with **extra length cable** allowing for quick and easy installations.
- High Power factor luminaire **>0.9**.
- Can be suspended by up to 2m with our optional suspension kit.

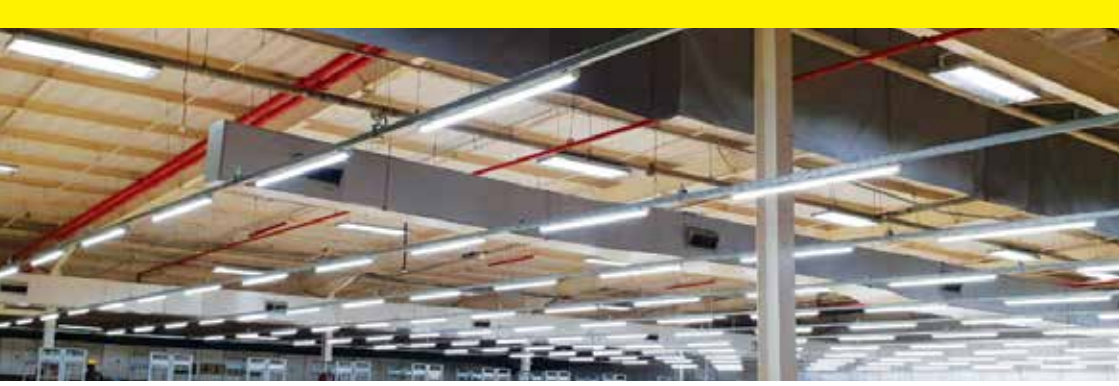

2FT

4000K (NW)

6000K (CW)

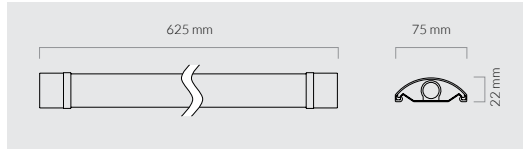

4FT

4000K (NW)

6000K (CW)

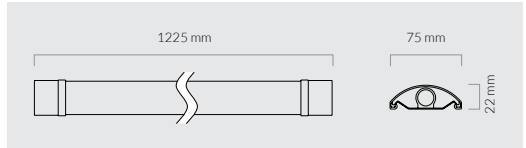

5FT

4000K (NW)

6000K (CW)

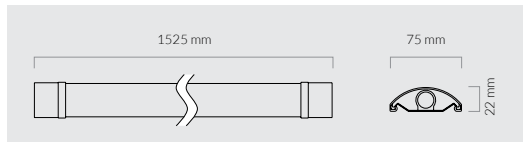

CODE	DESCRIPTION	LUMEN OUTPUT	CRI	BEAM	INPUT VOLTAGE	HOUSING	OPERATING TEMP	LED CHIPS
LL604	18W IP65 Ultra Slim Linear Light 2ft 6000K	1 600						
LL606	18W IP65 Ultra Slim Linear Light 2ft 4000K	1 600						
LL607	36W IP65 Ultra Slim Linear Light 4ft 6000K	3 200						
LL609	36W IP65 Ultra Slim Linear Light 4ft 4000K	3 200	>83	120°	185V-277V	PC and Internal Alu	-20-45°C	2835 Sanan
LL610	45W IP65 Ultra Slim Linear Light 5ft 6000K	4 000						
LL612	45W IP65 Ultra Slim Linear Light 5ft 4000K	4 000						
LL099	2M hanging strip for Linear light							



IP33 PROJECT LINEAR LIGHT



Certificates: CE, IEC60598, EMC, RoHS, ISO9001



Suspension kit

FEATURES

- **Pure Aluminium corrosion resistant** body which provides as a heat sink.
- Elegant and aesthetically **unobtrusive design** designed for demanding applications.
- Replaces traditional open channel fluorescent luminaires.
- Effective lumen output of up to **90lm/W**.
- High Power factor **> 0.9**
- 304 grade clips.
- **Flicker Free**, Suitable for hospitals, schools, offices, kitchens etc.
- Opal diffuser **creating a soft uniform** light distribution eliminating any visuals of the raw SMD LED.
- Complete with extra length pre-wired cable.
- Can be **suspended by up to 2m** with our optional suspension kit.
- Environmentally friendly containing no mercury, lead or other harmful substances.
- **IP33 rated luminaire** with built in 1kV Surge protection.

CODE	DESCRIPTION	LUMEN OUTPUT	CRI	BEAM	INPUT VOLTAGE	HOUSING	OPERATING TEMP	LED CHIPS						
LL001	10W IP33 Slim Project Linear Light 6000K 1ft	900	>83	150°	185V-277V	PC and Pure Alu	-20~45°C	2835 Sanan						
LL003	10W IP33 Slim Project Linear Light 4000K 1ft	900												
LL004	20W IP33 Slim Project Linear Light 6000K 2ft	1800												
LL005	20W IP33 Slim Project Linear Light 3000K 2ft	1800												
LL006	20W IP33 Slim Project Linear Light 4000K 2ft	1800												
LL007	40W IP33 Slim Project Linear Light 6000K 4ft	3600												
LL008	40W IP33 Slim Project Linear Light 3000K 4ft	3600												
LL009	40W IP33 Slim Project Linear Light 4000K 4ft	3600												
LL010	60W IP33 Slim Project Linear Light 6000K 5ft	5400												
LL012	60W IP33 Slim Project Linear Light 4000K 5ft	5400												
LL099	2M hanging strip for Linear light													

10W **1FT**

4000K (NW)
6000K (CW)

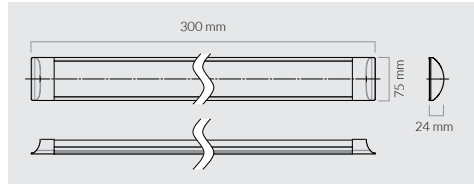

20W **2FT**

6000K
4000K
3000K

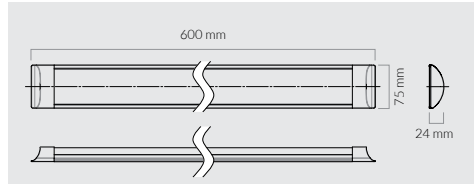

40W **4FT**

6000K
4000K
3000K

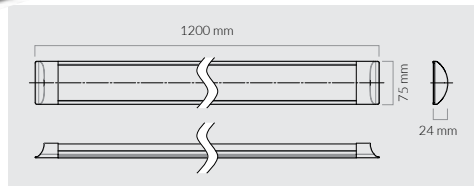

60W **5FT**

4000K (NW)
6000K (CW)

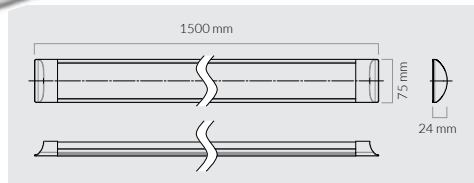

PREMIUM



IP65 LED LINEAR LIGHT



Certificates: CE, IEC60598, EMC, RoHS, ISO9001

40W

4000K (NW)
6000K (CW)

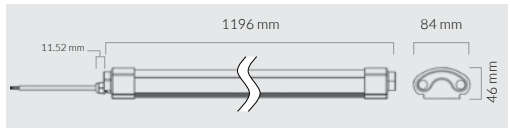

60W

4000K (NW)
6000K (CW)

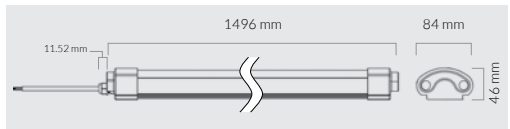

FEATURES

- Pure Aluminum **Coastal Spec IP65** weatherproof linear.
- Maintenance free luminaire **equivalent to 2 x fluorescent tubes** in a vapour proof body.
- **Anti UV diffuser** allowing for uniform light distribution.
- Comes complete with extra length **side entry** installation cable.
- Effective lumen output of up to **90lm/W**.
- Robust design allowing for the most demanding applications.
- Operating Temperature: **-20°C to 40°C**
- High Power factor **> 0.9**
- Ceiling/Wall Mount or suspendable by up to 2m with our optional suspension kit.
- Maintenance free, environmentally friendly alternative to halogen lamps which contain no mercury, lead or other harmful substances.
- **304 grade clips**.

CODE	DESCRIPTION	LUMEN OUTPUT	CRI	BEAM	INPUT VOLTAGE	HOUSING	OPERATING TEMP	LED CHIPS
LL207	40W IP65 Slim Project Linear Light 4ft 6000K	3 600	>83	120°	185V- 277V	Pure Alu	-20-40°C	Sanan 2835
LL209	40W IP65 Slim Project Linear Light 4ft 4000K	3 600						
LL210	60W IP65 Slim Project Linear Light 5ft 6000K	5 400						
LL212	60W IP65 Slim Project Linear Light 5ft 4000K	5 400						
LL099	2M hanging strip for Linear light							

NANO LINEAR LIGHT

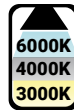

Certificates: CE, EMC, IEC60598

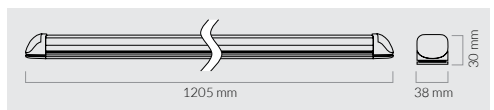
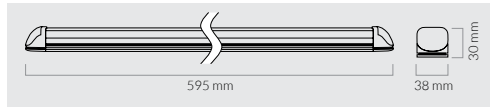

FEATURES

- Unique **thermal management** system with an aluminium body allowing for the aesthetic look of a single tube in an open channel fixture.
- **Ultra Slim design** coupled with an effective lumen output of up to **95lm/W**.
- **Back entry extra length cable**, for a quick, neat and efficient installation.
- Durable LED Linear with a built in **1kV Surge Protection**.
- Can be suspended up to 2m with our optional suspension kit.
- High **Power factor > 0.9**
- Environmentally friendly containing no mercury, lead or other harmful substances.

CODE	DESCRIPTION	LUMEN OUTPUT	CRI	BEAM	INPUT VOLTAGE	HOUSING	OPERATING TEMP	LED CHIPS
LL401	10W Nano Slim Linear Light 1ft 6000K	950	>83	132°	185V- 265V	Pure Alu	-20~45°C	Sanan 2835
LL404	18W Nano Slim Linear Light 2ft 6000K	1 710						
LL405	18W Nano Slim Linear Light 2ft 3000K	1 710						
LL406	18W Nano Slim Linear Light 2ft 4000K	1 710						
LL407	36W Nano Slim Linear Light 4ft 6000K	3 420						
LL408	36W Nano Slim Linear Light 4ft 3000K	3 420						
LL409	36W Nano Slim Linear Light 4ft 4000K	3 420						
LL099	2M hanging strip for Linear light							



3CCT TRI-PROOF LINEAR

BATTERY BACKUP SUITABLE



Certificates: CE, EMC, IEC60598, ErP

FEATURES

- **3CCT (3000K/4000K/6000K)** Vapour Proof LED Linear switchable via integrated Dipswitch.
- Seamless installation with our **linkable LYNX**. Connect up to 12pcs (4ft) and 9pcs (5ft) in series.
- Ultra High Lumen **2835 SMD LED Chips** with an effective lumen output of 150lm/W.
- Wide **120° beam angle** for maximum coverage and uniformity.
- **EMC Flicker Free** power supply with a built in 1.5kV Surge Protection.
- **Coastal Spec PC housing** with Stainless Steel Clips and a UV protected PC lens.
- Designed for use in the most demanding environments with its **IP65 rated housing, 5 year warranty** and **-20°C ~ 40°C** operating temperature.

36W 4FT

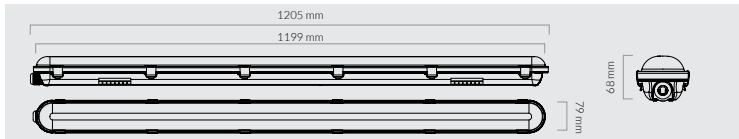

48W 5FT

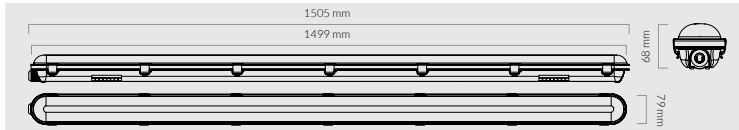

CODE	DESCRIPTION	LUMEN OUTPUT	CRI	BEAM	INPUT VOLTAGE	HOUSING	OPERATING TEMP	LED CHIP
LL702	36W Lynx 3CCT Tri-proof Linear Light	5 400	>83	120°	190V-277V	PC	-20~40°C	2835 Sanan
LL703	48W Lynx 3CCT Tri-proof Linear Light	7 200						
R102	IP65 10kV Surge Protection 5Amp							

IP65 TRI-PROOF FIXTURE



2FT

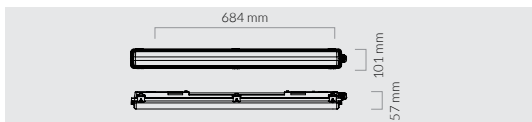

4FT

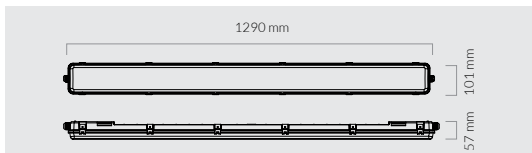

5FT

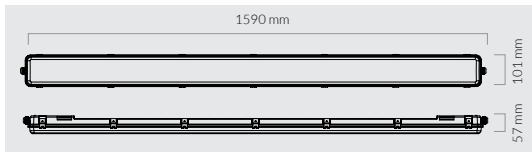

FEATURES

- **Sleek and Slim** appearance, IP65 rated **weatherproof** body **pre-wired** for double T8 LED Tubes.
- **Anti-UV PC Cover** and ABS Body with 301 **Stainless Steel Clips**.
- Prismatic **Polycarbonate diffuser** designed to reduce glare from the LED Tubes
- Ideal for use in **harsh conditions** with its non-corrosive and durable housing (suitable for **cold rooms** as well).
- **Quick and easy** installation either via mounting clips or suspension.
- Comes complete with an IP65 rated gland and a **knock out** allowing for installations in series.

CODE	DESCRIPTION	HOUSING
TF008	Zen Tri-Proof 2ft PC Fixtures for 2xT8 LED	PC Cover + Stainless Steel Clips + ABS Body + White Reflector Enhancing The Brightness For Single Side Power LED T8 Tubes Use
TF010	Zen Tri-Proof 4ft PC Fixtures for 2xT8 LED	
TF012	Zen Tri-Proof 5ft PC Fixtures for 2xT8 LED	

T8 COMBAT LED TUBES



Certificates: CE, EMC, RoHS, ISO9001



FEATURES

- Frosted Glass housing helping in the **reduction of glare** whilst allowing for **ultra-fast heat dissipation** increasing the lifespan of the LEDs.
- **Pure aluminium end caps** giving the tube the look and feel of fluorescents without the high-power consumption/ negative environmental impacts.
- Quick and fast installation with **220V power to one side** only.
- **1kV surge protection** built in.
- **2835 SMD LED Chips** for a brighter, more efficient LED lamp.
- The ideal lamp for all residential applications.
- Maintenance free alternative to fluorescent lamps with a much lower lumen decay rate.
- Instant on LED tube with no warm-up time.



CODE	DESCRIPTION	LUMEN OUTPUT	CRI	BEAM	INPUT VOLTAGE	HOUSING	OPERATING TEMP	LED CHIPS
T105	10W T8 Combat Glass Tube 2ft 6000K	900	>83	270°	180V-265V	Glass and Alu end caps	-20~45°C	2835 Sanan
T106	10W T8 Combat Glass Tube 2ft 4000K	900						
T107	10W T8 Combat Glass Tube 2ft 3000K	900						
T101	18W T8 Combat Glass Tube 4ft 6000K	1 600						
T102	18W T8 Combat Glass Tube 4ft 4000K	1 600						
T108	18W T8 Combat Glass Tube 4ft 3000K	1 600						
T103.2	24W T8 Combat Glass Tube 5ft 6000K	2 200						
T104	24W T8 Combat Glass Tube 5ft 4000K	2 200						
T109	24W T8 Combat Glass Tube 5ft 3000K	2 200						

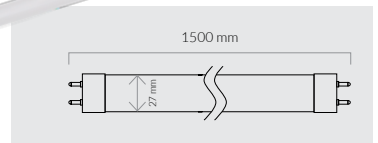
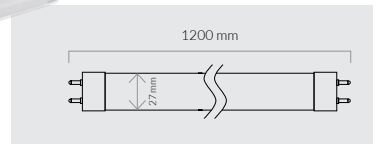
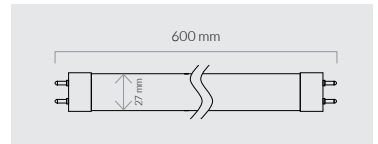



PREMIUM

T8 PREMIUM LED TUBES



Certificates: CE, EMC, IEC60598



FEATURES

- Frosted Glass housing helping in the **reduction of glare** coupled with an internal **aluminium backing** to provide as a heat sink.
- Easy to install for either new or retrofit installations with direct **220V from one end** only.
- Maintenance free LED Tube requiring no ballast or starters.
- High Power Factor **> 0.9** making this the ideal lamp for commercial/ industrial applications.
- **Robust**, LED tube with built in **1kV surge protection** ensuring hassle free illumination.
- **270° Wide** Beam angle coupled with **aluminium** end caps providing a traditional tube feel.
- 2835 High Brightness SMD LED Chips with an effective **100lm/W** serving as a direct replacement to fluorescent tubes.
- The environmentally friendly alternative containing no mercury, lead or other harmful substances making it easy to recycle.

CODE	DESCRIPTION	LUMEN OUTPUT	CRI	BEAM	INPUT VOLTAGE	HOUSING	OPERATING TEMP	LED CHIPS
T005	10W T8 Premium Glass Tube 2ft 6000K	1 000	>83	270°	100V-277V	Glass and Alu end caps	-20~45°C	2835 Sanan
T001	18W T8 Premium Glass Tube 4ft 6000K	1 800						
T002	18W T8 Premium Glass Tube 4ft 4000K	1 750						
T003	24W T8 Premium Glass Tube 5ft 6000K	2 400						

10W **2FT** **6000K (CW)**

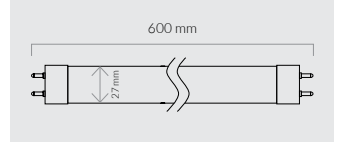

18W **4FT** **4000K (NW)**
6000K (CW)

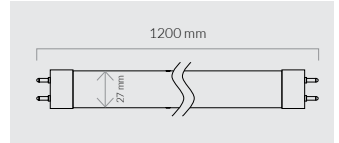

24W **5FT** **6000K (CW)**

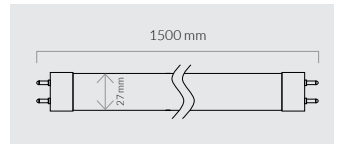

T5 COMBAT LED TUBES



Certificates: CE,EMC,IEC60598



FEATURES

- **Frosted Glass** diffuser coupled with internal aluminium providing fast and efficient heat dissipation.
- **Aluminium end caps** providing a traditional T5 fluorescent look and feel.
- **Direct 220V LED Lamp** with no requirements for traditional ballasts or starters.
- 2835 SMD LED Chips delivering 90lm/W with a **270° beam angle**.
- The perfect LED tube for day to day usage with a built in **1kV surge protection**.
- Wide input voltage range from **180-265V**.
- Instant on LED Tube with no warm up time.
- **High CRI>80** ideal for environments which require high colour rendering.
- Maintenance free alternative to fluorescent lamps with a much lower lumen decay rate.



CODE	DESCRIPTION	LUMEN OUTPUT	CRI	BEAM	INPUT VOLTAGE	HOUSING	OPERATING TEMP	LED CHIPS
T501	18W T5 Glass Tube 4ft 6000K	1 600	>83	270°	180V-265V	Glass and Alu end caps	-20~45°C	2835 Sanan
T502	18W T5 Glass Tube 4ft 4000K	1 600						
T503	20W T5 Glass Tube 5ft 6000K	1 800						
T504	20W T5 Glass Tube 5ft 4000K	1 800						
T505	10W T5 Glass Tube 2ft 6000K	800						
T506	10W T5 Glass Tube 2ft 4000K	800						

10W
2FT
4000K (NW)
6000K (CW)

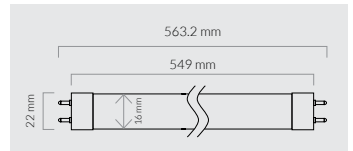

18W
4FT
4000K (NW)
6000K (CW)

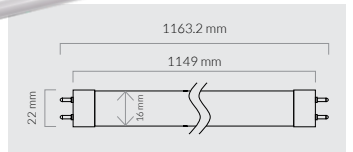

20W
5FT
4000K (NW)
6000K (CW)

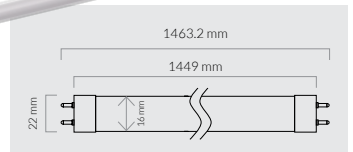

BAZUKA

35W TRACK SPOT LIGHT 3 WIRE/SURFACE

AVAILABLE IN
SURFACE



Certificates: CE, EMC, IEC60598

FEATURES

- **Dynamic Dual Heat Sink** ensuring longevity and the reduction in lumen depreciation.
- **High Lumen COB LED** coupled with a high-performance lens delivering an effective 100lm/W.
- **Elegant**, sophisticated look bringing style to your application.
- **340° rotation** allowing for precise aiming.
- **3 Wire system** for use in all single-phase circuits.
- **Deep reflector (36°)** helps in the reduction of glare whilst not impacting lumen output.
- Matt black or chique white trendy powder coated finish.
- **3kV built in surge protection** designed to withstand the toughest environments.
- **High spec driver** with a high PF>0.9 – ideal for retail/commercial industries.



CODE	DESCRIPTION	LUMEN OUTPUT	CRI	BEAM	INPUT VOLTAGE	HOUSING	OPERATING TEMP	LED CHIPS
TKB101	35W Bazuka 3 Wire Track 6000K Black	3 500	>83	36°	200V-265V	Pure Alu	-15-45°C	COB
TKB102	35W Bazuka 3 Wire Track 4000K Black							
TKB103	35W Bazuka 3 Wire Track 3000K Black							
TKW101	35W Bazuka 3 Wire Track 6000K White							
TKW102	35W Bazuka 3 Wire Track 4000K White							
TKW103	35W Bazuka 3 Wire Track 3000K White							
TSB101	35W Surface Bazuka 6000K Black							
TSB102	35W Surface Bazuka 4000K Black							
TSB103	35W Surface Bazuka 3000K Black							
TSW101	35W Surface Bazuka 6000K White							
TSW102	35W Surface Bazuka 4000K White							
TSW103	35W Surface Bazuka 3000K White							
TK100	30W Dim Driver for Bazuka Track Spot							

BAZUKA

ACCESSORIES



Multi Angle Connector 3
Wire Black or White

Black **TKB121**
White **TKW121**



2 or 3 metre 3 Wire Track Set
(including Power Feed & End Cap)
Black or White

2M Black **TKB111**
2M White **TKW111**
3M Black **TKB112**
3M White **TKW112**



End cap 3 Wire
Black or White

Black **TKB119**
White **TKW119**



Track adapter 3 Wire
Black or White

Black **TKB120**
White **TKW120**



I-Connector 3 Wire
Black or White

Black **TKB114**
White **TKW114**



Power Feed 3 Wire
Black or White

Black **TKB113**
White **TKW113**



L-Connector 3 Wire
Black or White

Black **TKB116**
White **TKW116**



T-Connector 3 Wire
Black or White

Black **TKB117**
White **TKW117**



X-Connector 3 Wire
Black or White

Black **TKB118**
White **TKW118**



Slim I-Connector 3 Wire
Black or White

Black **TKB115**
White **TKW115**





SNYPA LED SPOT



Certificates: CE, RoHS

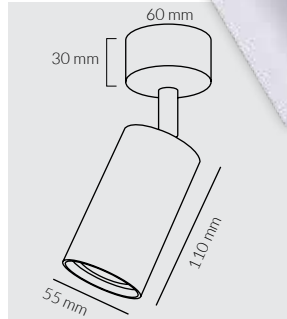
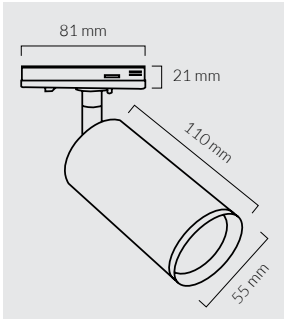

FEATURES

- Available in either **surface mount or 3 wire variants**.
- **110mm in length**, this track spot is designed to take most GU10 lamps.
- **Pure Aluminium** heat sink helping in the effective dissipation of the LED lamp.
- Ideal for residential/commercial applications where our Bazuka LED spot is too powerful.
- **Matt white or black** housing optional.

CODE	DESCRIPTION	NOTES
R301	Snypa GU10 3 wire Track 110m Black fitting	*No tools required to remove the lamp
R302	Snypa GU10 3 wire Track 110m White fitting	
R311	Snypa GU10 Surface 110m Black fitting	
R312	Snypa GU10 Surface 110m White fitting	



LEDA

3 WIRE BLACK TRACK LIGHT

Coming Soon



SYLO

SURFACE MOUNT WALL LIGHT FIXTURE



2
YEAR
WARRANTY

IP
65

Certificates: CE, IEC60598



FEATURES

- **Coastal Grade PC & ABS** Housing designed for maintenance free Coastal use.
- Suitable for outdoor use with its **IP65 rating**.
- Available in **Matt Black**.
- **Clear PC lens** allowing for uninterrupted clear illumination.
- Available in **Square or Round** with **UP&DOWN** or just **DOWN** options.
- Housing is Suitable for **PC GU10 Lamps** less than **6W**.

SQUARE DOWN

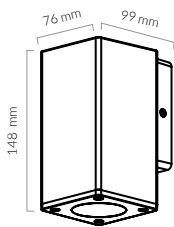

ROUND DOWN

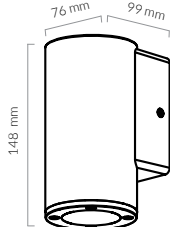

SQUARE UP & DOWN

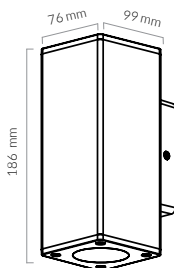

ROUND UP & DOWN

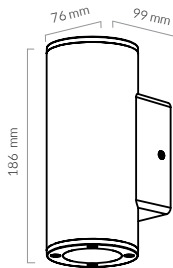

CODE	DESCRIPTION	HOUSING
R331	Sylo Surface Mount IP65 UP&DOWN Wall Fixture for GU10 Square	ABS + PC Material, PC Diffuser
R332	Sylo Surface Mount IP65 UP&DOWN Wall Fixture for GU10 Round	
R333	Sylo Surface Mount IP65 DOWN Wall Fixture for GU10 Square	
R334	Sylo Surface Mount IP65 DOWN Wall Fixture for GU10 Round	



3CCT LED WALL LIGHT



Certificates: CE, IEC60598, ErP

FEATURES

- **Coastal Grade PC & ABS** Housing designed for maintenance free Coastal use.
- Suitable for outdoor use with its **IP65 rating**.
- Available in **Matt Black** or **White** quickly customisable with our **Snap on Trims**.
- **Clear PC lens** allowing for uninterrupted clear illumination.
- Available in **UP&DOWN** or just **DOWN** options.
- 3CCT Variant with Warm White/ Natural White/Cool White controlled via **Dipswitch**.

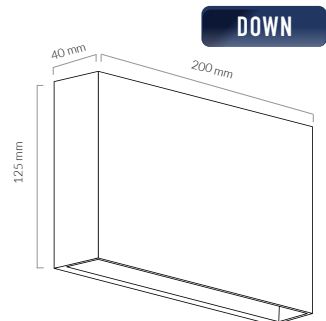
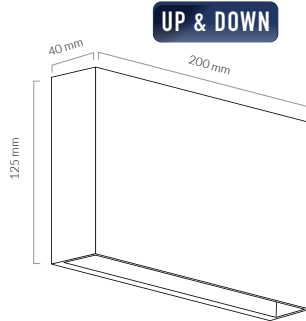

CODE	DESCRIPTION	LUMEN OUTPUT	CRI	BEAM	INPUT VOLTAGE	HOUSING	OPERATING TEMP	LED CHIP
R401	Surface Mount IP65 12W 3CCT IP65 Up&Down PC Wall light Black	700	>80	100°	200-260V	ABS + PC	-20~40°C	2835 SMD
R402	Surface Mount IP65 6W 3CCT IP65 Down PC Wall light Black	500						
R403	Accessory - White PC Case for Pandora Up&Down							
R404	Accessory - White PC Case for Pandora Down							

12V/24V IP20/IP67 STRIP LIGHTS



Certificates: CE, RohS, ISO9001



FEATURES

- Highly customizable with cutting points every 50mm.
- Genuine **3M adhesive backing tape** for safe and quick installation.
- High **CRI>80** ideal for specialized environments which require high colour rendering.
- **120° wide beam** angle LED strip.
- **Sanán SMD LED Chips** with an efficacy of > 100lm/W.
- Increase the LED lifespan whilst reducing lumen decay by adding either our surface, recessed or corner pure aluminium profiles.
- Safe to use in open areas as the LED strip provides minimal heat and is only 12V and 24V.
- Available in either **IP20** or fully enclosed coated **IP65**.
- 2/3oz thick PCB for super fast heat dissipation.
- All our LED strips are **dimable** when coupled with our wireless dimmer.
- Available in either Warm White 3000K, Neutral White 4000K, Cool White 6000K, **Red, Blue, Green or RGB**, catering for all application requirements.
- Ideal for commercial/ residential applications.

AMBIENCE

4.8W /M 24V 12V

6000K 4000K 3000K BLUE IP 20/65

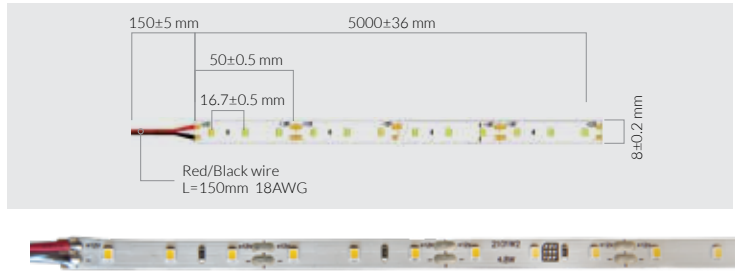

EXCLUSIVE

9.6W /M 24V 12V

6000K 4000K 3000K

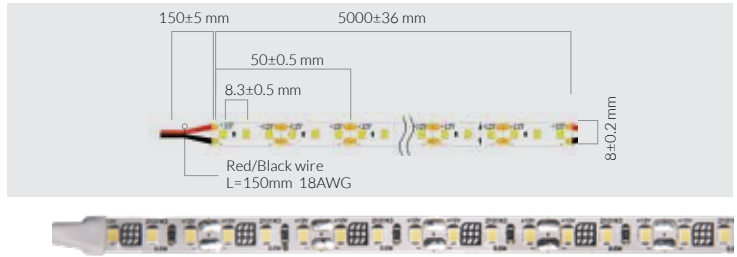

SUPER BRIGHT

14.4W /M 24V 12V

6000K 4000K 3000K IP 20/65

RGB RED GREEN BLUE

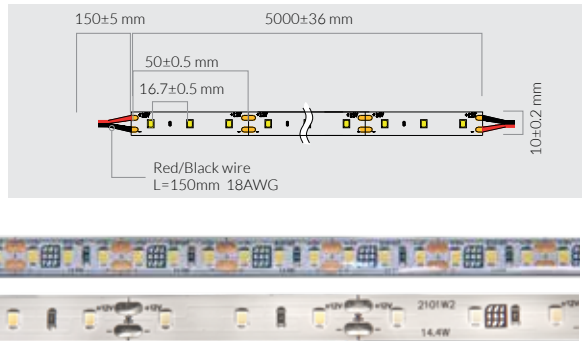

EXTENSION

10W /M 24V

BLUE 6000K 4000K 3000K IP 65

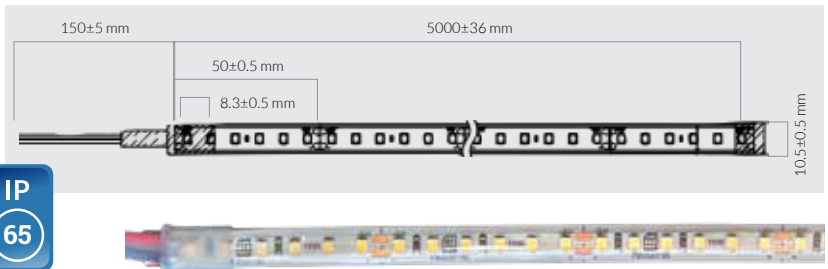

STRIP LIGHT/SURGE PROTECTION ACCESSORIES



R001
RGB Amplifier 12V/24V
L105 x W65 x H23



R002
RGB Controller 12V/24V
with Remote - 5m
L61 x W35 x H22



R003
RGB Controller
12V/24V - 10M
L130 x W64 x H24



R004
Wireless dimmer 12V/24V with
Remote- 5M. Max 6Amp
L115 x W56 x H34



R005
RGBW WIFI Smart
Battery: 2032
Controller 12V/24V
with Remote -
230/460W



R109
Smartie
Cable Connector



R102
IP65
10kV Surge Protection
Max 5Amp - 4 Wire Series



R104
IP65 10kV Surge Protection
Max 8Amp - 6 Wire



R007
10mm Single Colour
2way Connector
L180 x W14 x H4.6



R008
10mm Single Colour
Connector
L15 x W14 x H4.6



R009
10mm RGB 2way
Connector
L180 x W14 x H4.6



R010
8mm Single Colour 2way
Connector
L180 x W12 x H4.6



R011
8mm Single Colour
Connector
L15x W12 xH4.6

CODE	DESCRIPTION	LUMEN OUTPUT	CRI	BEAM	INPUT VOLTAGE	DIMMABLE	LED CHIPS
S001	14.4W 12V IP20 Strip 6000K - 1M 60 LED/M	1 100 lm/m	>83	120°	DC12V	Yes	2835 SMD
S009	14.4W 12V IP20 Strip 4000K - 1M 60 LED/M	1 100 lm/m					
S003	14.4W 12V IP20 Strip 3000K - 1M 60 LED/M	1 100 lm/m					
S005	14.4W 12V IP20 Strip Blue - 1M 60 LED/M						
S012	14.4W 12V IP20 Strip Green - 1M 60 LED/M						
S011	14.4W 12V IP20 Strip Red - 1M 60 LED/M						
S007	14.4W 12V IP20 Strip RGB - 1M 60 LED/M						
SR001	14.4W 12V IP20 Strip 6000K - 5M 60 LED/M	1 100 lm/m					
SR009	14.4W 12V IP20 Strip 4000K - 5M 60 LED/M	1 100 lm/m					
SR003	14.4W 12V IP20 Strip 3000K - 5M 60 LED/M	1 100 lm/m					
SR005	14.4W 12V IP20 Strip Blue - 5M 60 LED/M						
SR012	14.4W 12V IP20 Strip Green - 5M 60 LED/M						
SR011	14.4W 12V IP20 Strip Red - 5M 60 LED/M						
SR007	14.4W 12V IP20 Strip RGB - 5M 60 LED/M						
S013	9.6W 12V IP20 Strip 6000K - 1M 120 LED/M	960 lm/m	>83	120°	DC12V	Yes	2835 SMD
S015	9.6W 12V IP20 Strip 4000K - 1M 120 LED/M	960 lm/m					
S014	9.6W 12V IP20 Strip 3000K - 1M 120 LED/M	960 lm/m					

SR013	9.6W 12V IP20 Strip 6000K - 5M 120 LED/M	960 lm/m						
SR015	9.6W 12V IP20 Strip 4000K - 5M 120 LED/M	960 lm/m						
SR014	9.6W 12V IP20 Strip 3000K - 5M 120 LED/M	960 lm/m						
S002	4.8W 12V IP20 Strip 6000K - 1M 60 LED/M	500 lm/m						
S010	4.8W 12V IP20 Strip 4000K - 1M 60 LED/M	500 lm/m						
S004	4.8W 12V IP20 Strip 3000K - 1M 60 LED/M	500 lm/m						
S006	4.8W 12V IP20 Strip Blue - 1M 60 LED/M	500 lm/m	>83	120°	DC12V	Yes	2835 SMD	
SR002	4.8W 12V IP20 Strip 6000K - 5M 60 LED/M	500 lm/m						
SR010	4.8W 12V IP20 Strip 4000K - 5M 60 LED/M	500 lm/m						
SR004	4.8W 12V IP20 Strip 3000K - 5M 60 LED/M	500 lm/m						
SR006	4.8W 12V IP20 Strip Blue - 5M 60 LED/M	500 lm/m						
S213	9.6W 24V IP20 Strip 6000K - 1M 120 LED/M	960 lm/m						
S215	9.6W 24V IP20 Strip 4000K - 1M 120 LED/M	960 lm/m						
S214	9.6W 24V IP20 Strip 3000K - 1M 120 LED/M	960 lm/m						
SR213	9.6W 24V IP20 Strip 6000K - 10M 120 LED/M	960 lm/m						
SR215	9.6W 24V IP20 Strip 4000K - 10M 120 LED/M	960 lm/m	>83	120°	DC24V	Yes	2835 SMD	
SR214	9.6W 24V IP20 Strip 3000K - 10M 120 LED/M	960 lm/m						
S212	4.8W 24V IP20 Strip 4000K - 1M 60 LED/M	500 lm/m						
S211	4.8W 24V IP20 Strip 3000K - 1M 60 LED/M	500 lm/m						
SR212	4.8W 24V IP20 Strip 4000K - 10M 60 LED/M	500 lm/m						
SR211	4.8W 24V IP20 Strip 3000K - 10M 60 LED/M	500 lm/m						
SW207	14.4W 24V IP65 Outdoor Strip RGB - 1M 60 LED/M			120°	DC24V			5050 SMD
SWR207	14.4W 24V IP65 Outdoor Strip RGB - 10M 60 LED/M							
SW004	4.8W 24V IP65 Strip 4000K - 1M 60 LED/M	500 lm/m						
SW002	4.8W 24V IP65 Strip 6000K - 1M 60 LED/M	500 lm/m						
SW010	4.8W 24V IP65 Strip 3000K - 1M 60 LED/M	500 lm/m		120°	DC24V		2835 SMD	
SWR004	4.8W 24V IP65 Strip 4000K - 10M 60 LED/M	500 lm/m						
SWR002	4.8W 24V IP65 Strip 6000K - 10M 60 LED/M	500 lm/m						
SWR010	4.8W 24V IP65 Strip 3000K - 10M 60 LED/M	500 lm/m						
SW001	14.4W 12V IP65 Outdoor Strip 6000K - 1M 120 LED/M	1 400 lm/m						
SW009	14.4W 12V IP65 Outdoor Strip 4000K - 1M 120 LED/M	1 400 lm/m						
SW003	14.4W 12V IP65 Outdoor Strip 3000K - 1M 120 LED/M	1 400 lm/m						
SWR001	14.4W 12V IP65 Outdoor Strip 6000K - 5M 120 LED/M	1 400 lm/m	>83	120°	DC12V	Yes	2835 SMD	
SWR009	14.4W 12V IP65 Outdoor Strip 4000K - 5M 120 LED/M	1 400 lm/m						
SWR003	14.4W 12V IP65 Outdoor Strip 3000K - 5M 120 LED/M	1 400 lm/m						
SW011	10W 24V IP65 Outdoor Strip 6000K - 1M 120 LED/M	1 000 lm/m						
SW012	10W 24V IP65 Outdoor Strip 4000K - 1M 120 LED/M	1 000 lm/m						
SW013	10W 24V IP65 Outdoor Strip 3000K - 1M 120 LED/M	1 000 lm/m						
SW014	10W 24V IP65 Outdoor Strip Blue - 1M 120 LED/M	1 000 lm/m						
SWR011	10W 24V IP65 Outdoor Strip 6000K - 10M 120 LED/M	1 000 lm/m	>83	120°	DC24V	Yes	2835 SMD	
SWR012	10W 24V IP65 Outdoor Strip 4000K - 10M 120 LED/M	1 000 lm/m						
SWR013	10W 24V IP65 Outdoor Strip 3000K - 10M 120 LED/M	1 000 lm/m						
SWR014	10W 24V IP65 Outdoor Strip Blue - 10M 120 LED/M	1 000 lm/m						

COB DOTLESS STRIP



Certificates: CE, EMC



FEATURES

- 480 LED p/m **Uniform Dotless LED strip light** providing continuous illumination.
- **30z thick PCB**, designed to rapidly dissipate heat extending the LED Chips lifespan.
- Aluminium Profile is required when installing LED strip.
- Genuine **3M tape backing**, allowing for a long-lasting surface bonding solution.
- **Ultra-Customizable** with cutting points every 50mm.
- Available in 24V and requires pairing with one of our **24V DC Constant Voltage LED Drivers**.
- **Dimmable 24V COB LED Strip** with an Ultra High CRI > 90 for excellent colour rendering.
- 5m series installation with **no voltage drop**.
- Suitable for use in all **commercial/residential applications**.

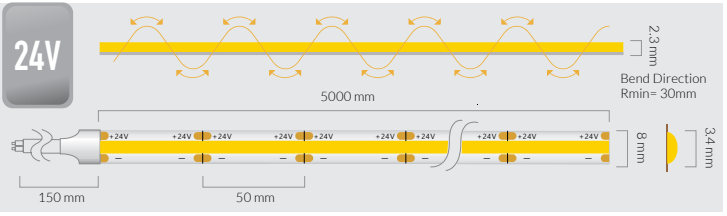
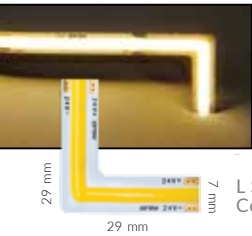

CODE	DESCRIPTION	LUMEN OUTPUT	CRI	BEAM	INPUT VOLTAGE	DIMMABLE	OPERATING TEMP	LED CHIP
S301	10W 24V COB IP20 Strip 6000K - 1M 480 LED/M	1 100lm/m	>90	180°	DC24V	Yes	-20~40°C	COB
S302	10W 24V COB IP20 Strip 4000K - 1M 480 LED/M							
S303	10W 24V COB IP20 Strip 3000K - 1M 480 LED/M							
SR301	10W 24V COB IP20 Strip 6000K - 5M 480 LED/M	1 100lm/m	>90	180°	DC24V	Yes	-20~40°C	COB
SR302	10W 24V COB IP20 Strip 4000K - 5M 480 LED/M							
SR303	10W 24V COB IP20 Strip 3000K - 5M 480 LED/M							
SR301L	10W 24V 480 COB IP20 Strip 6000K L Shaped Strip Joint							
SR302L	10W 24V 480 COB IP20 Strip 4000K L Shaped Strip Joint							
SR303L	10W 24V 480 COB IP20 Strip 3000K L Shaped Strip Joint							

230V COB CONTINUOUS DIMMABLE FLEX STRIP

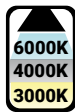

Certificates: CE, EMC, IEC60598

FEATURES

- 480 LED p/m **Uniform Dotless LED strip light** providing Linear illumination.
- **30z thick PCB**, designed to rapidly dissipate heat extending the LED Chips lifespan.
- Optional **3M Waterproof tape backing**, allowing for a long-lasting surface bonding solution.
- **Ultra-Customizable** with cutting points every 50cm.
- 50m series installation with **no voltage drop**.
- Suitable for use in all **commercial/residential applications**.
- Fits into all our aluminium profiles or our **230V Clear Profile**.

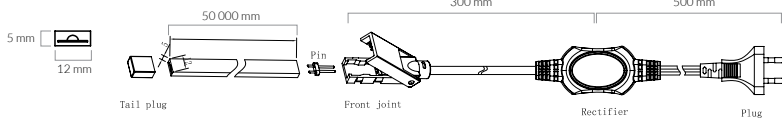

CODE	DESCRIPTION	LUMEN OUTPUT	CRI	BEAM	INPUT VOLTAGE	DIMMABLE	OPERATING TEMP	HOUSING	LED CHIP
X021	11W 230V COB IP65 Continuous Flex Strip 6000K - 50CM cut - 1M 480 LED/M								
X022	11W 230V COB IP65 Continuous Flex Strip 4000K - 50CM cut - 1M 480 LED/M								
X023	11W 230V COB IP65 Continuous Flex Strip 3000K - 50CM cut - 1M 480 LED/M								
X024	11W 230V COB IP65 Continuous Flex Strip Blue - 50CM cut - 1M 480 LED/M	1000lm/m	>83	180°	220V -265V	Yes	-20-40°C	Anti-UV Silicon	COB
XR021	11W 230V COB IP65 Continuous Flex Strip 6000K - 50CM cut - 50M 480 LED/M								
XR022	11W 230V COB IP65 Continuous Flex Strip 4000K - 50CM cut - 50M 480 LED/M								
XR023	11W 230V COB IP65 Continuous Flex Strip 3000K - 50CM cut - 50M 480 LED/M								
XR024	11W 230V COB IP65 Continuous Flex Strip Blue cut - 50M 480 LED/M								
XA016	Power plug IP20 for 230V COB Continuous Flex								
XA017	End cap for 230V COB Continuous Flex								
XA014	Clear PC Profile-2m								
R112	3M Waterproof 12mm 2-Side Tape 33m/R								



LED STRIP LIGHT ALUMINIUM PROFILES

1716 DOTLESS ALUMINIUM PROFILE

Surface / Recessed Aluminium Profile

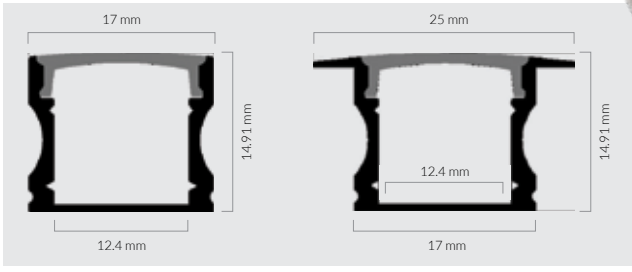

1616 CORNER ALUMINIUM PROFILES

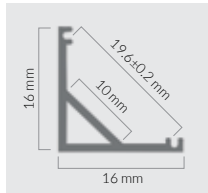

SLIM 27/28 ALUMINIUM PROFILES

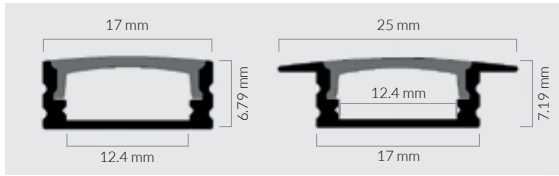

CODE	DESCRIPTION
CH311	Corner Profile S1616-2M
CH321	Opal Cover Round S1616 - 2M
CH331	Opal Cover Square S1616 - 2M
CH34	Steel Holder - S1616
CH351	End Cap for Round S1616 / pair
CH361	End Cap for Square S1616 / pair
CH37	90D Corner Connector S1616
CH41	AL Slim27 Surface Profile - 2M
CH42	Opal Cover Slim27n28n1716 - 2M
CH43	Clear Cover Slim27n28n1716 - 2M
CH44	End Cap Slim27 x 2 / Pair
CH45	Steel Holder for Slim27n28n1716
CH51	AL Slim28 Profile Recessed - 2M
CH52	End Cap Slim28 x 2 / Pair
CH61	AL Dotless 1716 Profile Surface - 2M
CH62	AL Dotless 1716 Profile Recessed - 2M
CH63	End Cap 1716 Surface x 2 / Pair
CH64	End Cap 1716 Recessed x 2 / Pair





LED 230V ROPE LIGHTS

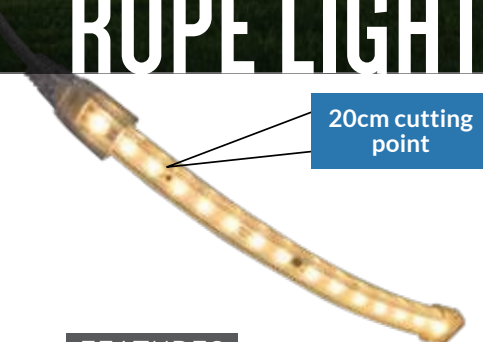

20cm cutting point

1 kV SURGE PROTECTION	90 LUMEN PER WATT	2 YEAR WARRANTY	PF 0.9	230V	DIM
------------------------------------	-----------------------------	---------------------------	---------------	-------------	------------

Certificates: CE, EMC, IEC60598

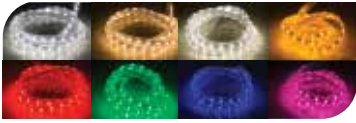

FEATURES

- Highly flexible PVC, **UV and Corrosion resistant**.
- **Prismatic diffuser** reducing glare with 98% light transmittance.
- New wireless PCB design, high safety level.
- Run up to **50 metre** off one power cord with **zero volt drop**.
- 2835 0.2W high efficiency LED, **PF>0.9**, every 1metre cutting point.
- Convenient to assemble, **patented plug design**.
- Integrated copper chip, **low heat** and good heat dissipation.
- Optional **3M Waterproof tape backing**, allowing for a long-lasting surface bonding solution.

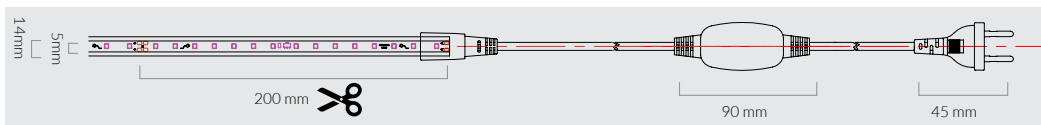
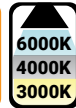
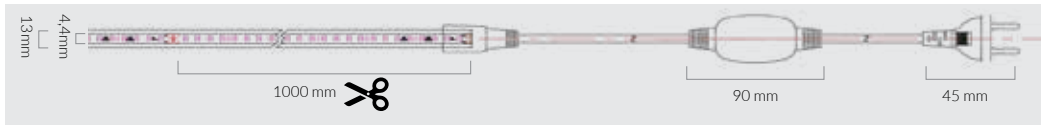

ROPE LIGHT ACCESSORIES



XA001
Max 50m LED Rope
Power Plug 230V
Single Colour • PVC
220V-260V



XA002
Max 50m LED Rope
Power Plug and Remote
230V RGB • Metal
220V-260V



XA003
PC Clip for 230V
Rope-1 Hole • PC
15 x 10 x 8.5 mm



XA004
PC Clip for 230V
Rope-2 Holes • PC
14.5 x 7 mm



XA005
End Cap for Rope Light
PVC
13.5 x 6 x 13.5 mm



XA007
End2End Connector Rope
Single Colour • PVC 45
x 17 x 10 mm



XA008
End2End Connector
Rope RGB IP20 • PC
40 x 25 x 10 mm



XA009/ XA010
Adh-Heatshrink D15/ D19 -
1M Rope • Single Colour
D15/D19



R112
3M Waterproof 12mm
2-Side Tape 33m/R

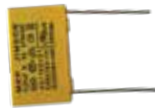

XA011
Yellow Capacitor
Dimmable



XA013
2 Way connector for 230V
Single Colour • PC
38 x 22 x 9 mm



**XA014
XA015**
2m Profile • Clear
Single Colour/RGB



CODE	DESCRIPTION	LUMEN OUTPUT	CRI	BEAM	INPUT VOLTAGE	HOUSING	LED CHIPS
X009	8W 230V IP65 Strip Lights-1M cut RGB /m		>83	120°	AC 220-260V	Highly Flexible PVC	2835 x 60pcs/m
XR009	8W 230V IP65 Strip Lights-1M cut RGB 50M						
X011	9W 230V IP65 Strip Lights 6000K 20CM cut	900lm/M					
X012	9W 230V IP65 Strip Lights 4000K 20CM cut	900lm/M					
X013	9W 230V IP65 Strip Lights 3000K 20CM cut	900lm/M					
X015	9W 230V IP65 Strip Lights Blue 20CM cut						
X016	9W 230V IP65 Strip Lights Red 20CM cut						
X017	9W 230V IP65 Strip Lights Green 20CM cut						
X018	9W 230V IP65 Strip Lights Amber 20CM cut						
X019	9W 230V IP65 Strip Lights Magenta 20CM cut						
XR011	9W 230V IP65 Strip Lights 6000K 20CM cut 50M	900lm/M					
XR012	9W 230V IP65 Strip Lights 4000K 20CM cut 50M	900lm/M					
XR013	9W 230V IP65 Strip Lights 3000K 20CM cut 50M	900lm/M	>83	120°	AC 220-260V	Highly Flexible PVC	2835x 75pcs/m
XR015	9W 230V IP65 Strip Lights Blue 20CM cut 50M						
XR016	9W 230V IP65 Strip Lights Red 20CM cut 50M						
XR017	9W 230V IP65 Strip Lights Green 20CM cut 50M						
XR018	9W 230V IP65 Strip Lights Amber 20CM cut 50M						
XR019	9W 230V IP65 Strip Lights Magenta 20CM cut 50M						
XR011a	9W 230V IP65 Strip Lights 6000K 20CM cut 100M	900lm/M					
XR012a	9W 230V IP65 Strip Lights 4000K 20CM cut 100M	900lm/M					
XR013a	9W 230V IP65 Strip Lights 3000K 20CM cut 100M	900lm/M					
XR015a	9W 230V IP65 Strip Lights Blue 20CM cut 100M						
XR016a	9W 230V IP65 Strip Lights Red 20CM cut 100M						
XR017a	9W 230V IP65 Strip Lights Green 20CM cut 100M						
XR018a	9W 230V IP65 Strip Lights Amber 20CM cut 100M						
XR019a	9W 230V IP65 Strip Lights Magenta 20CM cut 100M						
R112	3M Waterproof 12mm 2-Side Tape 33m/R						

LED DRIVERS

DC 12/24V



PS001
18W | IP20 | 1.5A
LED **12V** CV Driver
L93 x W45 x H25

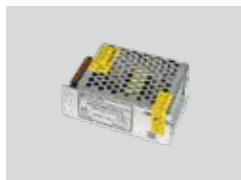

PS002
38W | IP20 | 3.2A
LED **12V** CV Driver
L85 x W58 x H33



PS003
60W | IP20 | 5A
LED **12V** CV Driver
L170 x W34 x H23



PS004
120W | IP20 | 10A
LED **12V** CV Driver
L205 x W48 x H29



PS005
200W | IP20 | 16.7A
LED **12V** CV Driver
L205 x W48 x H29



PS007
350W | IP20 | 29A
LED **12V** CV Driver
L230 x W115 x H50



PS008
50W | **IP67** | 4.1A
LED **12V** CV Driver
L202 x W35 x H25



PS009
100W | **IP67** | 8.2A
LED **12V** CV Driver
L183 x W63 x H18



PS002a
30W | IP20 | 1.25A
LED **24V** CV Driver
L135 x W35 x H23



PS003a
60W | IP20 | 2.5A
LED **24V** CV Driver
L170 x W35 x H23

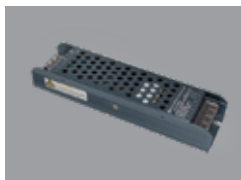

PS004a
120W | IP20 | 5A
LED **24V** CV Driver
L195 x W48 x H29



PS005a
200W | IP20 | 8.3A
LED **24V** CV Driver
L195 x W48 x H29



PS007a
400W | IP20 | 17A
LED **24V** CV Driver
L198 x W110 x H48

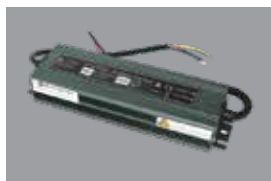

PS010
150W | **IP67** | 6A
LED **24V** CV Driver
L210 x W58 x H32



PS011
250W | **IP67** | 11A
LED **24V** CV Driver
L230 x W72 x H31





PIOLED FLOODLIGHT COVERAGE

WATTAGE	MOUNTING HEIGHT (metres)	EFFECTIVE AREA (sqm) FOR PIOLED...		
		NANO/COMBAT FLOODLIGHTS	THOR COASTAL FLOODLIGHTS	MODULAR HEAVY DUTY FLOODLIGHTS
10W	3 m	20 (4.5 x 4.5m)		
20W	3 m	36 (6 x 6m)	50 (7.2 x 7.2m)	
30W	5 m	55 (7.5 x 7.5m)	72 (8.5 x 8.5m)	
50W	5 m	85 (9 x 9m)	130 (11.5m x 11.5m)	
100W	5 m	170 (13 x 13m)	260 (16m x 16m)	350 (18.5 x 18.5m)
120W	8 m			520 (23 x 23m)
200W	8 m	340 (18.5 x 18.5m)	480 (22.5m x 22.5m)	
240W	8 m			780 (28 x 28m)
480W	8 m			1500 (39 x 39)
500W	8 m	900 (30 x 30m)		
960W	8 m			2500 (50 x 50)

**All sqm measurements are to be used as a guideline when selecting for general flood lighting applications only*





DURBAN HEAD OFFICE

Trafford Park, Unit 1B,
22-28 Trafford Road Pinetown,
Durban, South Africa

DURBAN NORTH XPRESS

10 Moreland Drive, Unit 10,
Northmead Industrial Park

031 701 5746

steven@pioledlighting.africa

EASTERN CAPE

063 298 1023

constant@pioledlighting.africa

JOHANNESBURG

Capital Hill 67 Unit 1,
Commercial Estate, Midrand,
Johannesburg, South Africa

010 020 5426

keegan@pioledlighting.africa

CAPE TOWN

6 Jig Road , Unit 4,
Montague Gardens,
Cape Town, South Africa

021 555 2399

ashraf@pioledlighting.africa

SCAN

to visit our
Website



www.pioledlighting.co.za

to add us on
WhatsApp



071 862 2789



www.pioledlighting.co.za

2022 | VOL. 2